

User Manual



FRM220-CH08 Hardware Installation



CTC UNION TECHNOLOGIES CO., LTD.

CTC Union Technologies Co., Ltd.
Far Eastern Vienna Technology Center (Neihu Technology Park)
8F, No. 60 Zhouzi St.
Neihu District
Taipei 114
Taiwan
Tel: +886-2-26591021
Fax: +886-2-27991355
Email: info@ctcu.com
URL: <http://www.ctcu.com>

FRM220-CH08 Hardware Installation Manual

Fiber In-band Managed
Media Platform Rack, 8 Slot, 1U

Version 1.0 February 7, 2012 (official release)

Copyright © 2011~2012, CTC Union Technologies, Inc.
All rights reserved.



All specifications are subject to change without prior notice.

Legal

The information in this publication has been carefully checked and is believed to be entirely accurate at the time of publication. CTC Union Technologies assumes no responsibility, however, for possible errors or omissions, or for any consequences resulting from the use of the information contained herein. CTC Union Technologies reserves the right to make changes in its products or product specifications with the intent to improve function or design at any time and without notice and is not required to update this documentation to reflect such changes.

CTC Union Technologies makes no warranty, representation, or guarantee regarding the suitability of its products for any particular purpose, nor does CTC Union assume any liability arising out of the application or use of any product and specifically disclaims any and all liability, including without limitation any consequential or incidental damages.

CTC Union products are not designed, intended, or authorized for use in systems or applications intended to support or sustain life, or for any other application in which the failure of the product could create a situation where personal injury or death may occur. Should the Buyer purchase or use a CTC Union product for any such unintended or unauthorized application, the Buyer shall indemnify and hold CTC Union Technologies and its officers, employees, subsidiaries, affiliates, and distributors harmless against all claims, costs, damages, expenses, and reasonable attorney fees arising out of, either directly or indirectly, any claim of personal injury or death that may be associated with such unintended or unauthorized use, even if such claim alleges that CTC Union Technologies was negligent regarding the design or manufacture of said product.

TRADEMARKS

Microsoft is a registered trademark of Microsoft Corp.

HyperTerminal™ is a registered trademark of Hilgraeve Inc.

WARNING:

This equipment has been tested and found to comply with the limits for a Class A digital device, pursuant to Part 15 of the FCC Rules. These limits are designed to provide reasonable protection against harmful interference when the equipment is operated in a commercial environment. This equipment generates, uses, and can radiate radio frequency energy and if not installed and used in accordance with the instruction manual may cause harmful interference in which case the user will be required to correct the interference at his own expense. NOTICE: (1) The changes or modifications not expressly approved by the party responsible for compliance could void the user's authority to operate the equipment. (2) Shielded interface cables and AC power cord, if any, must be used in order to comply with the emission limits.

CISPR PUB.22 Class A COMPLIANCE:

This device complies with EMC directive of the European Community and meets or exceeds the following technical standard. EN 55022 - Limits and Methods of Measurement of Radio Interference Characteristics of Information Technology Equipment. This device complies with CISPR Class A.

CE NOTICE

Marking by the symbol CE indicates compliance of this equipment to the EMC and LVD directives of the European Community. Such marking is indicative that this equipment meets or exceeds the following technical standards: EN 55022:2006, Class A, EN55024:1998+A1:2001+A2:2003, and EN60950-1:2001

Chapter 1 Introduction.....	7
1.0 Introduction.....	7
1.1 Functional Description.....	7
1.2 Chassis Front Description.....	7
1.3 LED Indicators and Alarm Relay.....	8
1.4 Chassis Rear Description.....	8
1.5 Chassis Physical Dimensions.....	8
1.6 Chassis Specifications.....	9
1.7 NMC (SNMP).....	9
1.8 Line card options.....	10
1.8.1 FRM220-10/100i In-band managed 10/100 Fiber Media Converter.....	10
1.8.2 FRM220-10/100iS-2 Dual Channel In-band managed 10/100 Fiber Media Converter.....	11
1.8.3 FRM220-10/100i-2E In-band managed 10/100 Fiber Media Converter.....	12
1.8.4 FRM220-10/100A(S) 802.3ah In-band managed 10/100 Fiber Media Converter.....	13
1.8.5 FRM220-1000EA(S) 802.3ah In-band managed Gigabit Fiber Media Converter.....	14
1.8.6 FRM220-1000EDS Managed Gigabit Fiber Media Converter.....	15
1.8.7 FRM220-E1/T1 In-band managed G.703 E1/T1(DS1) Fiber Modem.....	16
1.8.8 FRM220-Data In-band managed V.35, X.21, RS-530/449/232 Fiber Modem.....	17
1.8.9 FRM220-Serial/485 In-band managed RS-485/422/232 Fiber Modem.....	18
1.8.10 FRM220-FXO/FXS In-band managed POTS (Voice) over Fiber Modem.....	19
1.8.11 FRM220-155MS SM/MM, MM/SM converter / repeater.....	20
1.8.12 FRM220-2.7G-2S, 2.7Gbps 3R Fiber Transponder.....	21
1.8.13 FRM220-2.7G-3S 3R Transponder with Protection.....	22
1.8.14 FRM220-10G-xx 10Gbps 3R Fiber Transponder.....	23
1.8.15 FRM220-MD40/80 CWDM Mux/DeMux.....	24
1.8.16 FRM220-iMUX Inverse Multiplexer Blades.....	25
1.8.17 FRM220-Eoe1 Ethernet over E1 Converter.....	26
1.8.18 FRM220-E1/Data DSU/CSU Converter Card.....	27
1.8.19 FRM220-FTEC E1/T1 Cross Rate Converter Card.....	28
1.8.20 FRM220-1000TS GbE to Gigabit Fiber Converter Card.....	29
1.8.21 FRM220-4G 2R 4.25G Transponder Card.....	30
1.8.22 FRM220-Serial/FDC RS-485/RS-232 Fiber Ring Converter Card.....	31
1.8.23 FRM220-FOM04 4xE1/T1 +100M Ethernet Fiber Optical Multiplexer Card.....	32
Chapter 2 Installation.....	33
2.1 Introduction.....	33
2.2 Site Preparation.....	33
2.3 Mechanical Assembly.....	33
2.3.1 Rack mounting.....	33
2.3.2 Power/Fan Modules Removal/Replacement.....	34
2.3.3 Line Card Conversion, Stand-alone/Rack.....	34
2.4 Electrical Installation.....	35
2.5 Alarm Installation.....	35
2.6 NMC Card Installation.....	36
2.7 Line Card Installation.....	36
Chapter 3. Management Quick Start.....	37
3.1 Introduction.....	37
3.2 Management Methods.....	37
3.3 Console Terminal.....	37
3.3.1 Terminal Connection & Settings.....	37
3.3.2 Terminal Login.....	37
3.3.3 TCP/IP Setup.....	38
3.3.4 Test TCP/IP Connection.....	38
3.4 Telnet Terminal.....	39
3.5 Web Based Manager.....	39
3.6 Element Management System (EMS).....	40

Chapter 1 Introduction

1.0 Introduction

Thank you for choosing the 8-slot **FRM220** Platform Fiber Media Converter Rack. If you would like to skip right to the installation of the Converter Chassis, proceed to Chapter 2.

This manual is used to explain the hardware installation procedures for the **8-slot Converter Rack**, and present its capabilities and specifications. This manual is divided into 3 Sections, the Introduction, the Installation, plus a Management Quick Start. The Management Quick Start includes further information on options for placing the device in service.

Installers should carefully read Chapter 2, Installation. Network Administrators should read Chapter 3, Management Quick Start. The companion document, the **FRM220 NMC User Manual**, is available in electronic format only. The divisions in that manual are intended for use by personnel to answer questions in general areas. Planners and potential purchasers may read the Introduction to determine the suitability of the product to its intended use; Operating Personnel would use the Operations and Web Based Management Chapters and Appendices to become familiar with the line cards and settings. Network Administrators should read the chapters on Operation, Web Based Management and Trouble Shooting to become familiar with the diagnostic capabilities, network settings and management strategies for the SNMP managed chassis.

1.1 Functional Description

The **FRM220-CH08** is a 1U high 19" Rack, 8 slot modular media converter center. The **Modular Media Chassis** provides an economic solution for high density Fiber Converter installations in enterprises or central offices. All critical components, Power, fans, management module and interface cards are hot swappable allowing online field replacement. An additional feature allows the **Media Chassis** to detect the working or failing status either of power module or any fan assembly in the unit and activate relays that can be used to control external alarm devices.

There are 8 slots available for installation of **FRM220 Cards** in the **Media Chassis** compact rack. An SNMP Card is installed in the far left hand, upper slot, for local and remote management purposes. Each **FRM220** Card is an independent media converter. When linked to a compatible FRM220 Series stand-alone or "I" series FMC (Fiber Media Converter) stand-alone converter, complete in-band management is supported. All settings of the line card and remote connected stand-alone device may be managed through any of the available management interfaces. A variety of cards are available that support multi-mode or single-mode fiber types and connections to SC, ST, FC or even the latest bi-directional single fiber WDM (Wave Division Multiplexing) in ranges from 2Km to 120Km. Converter cards include Fast Ethernet, Gigabit Ethernet, Serial (RS-485, RS-232 and RS-422), ITU-T G.703 E1 and T1, Synchronous and Asynchronous Datacom (V.35, RS-530, X.21, RS-449, and RS-232), 155.52M STM-1 repeater, transponders for 2.7G, 4G and 10G, FXO/FXS over fiber and more as the product matures.

The **Media Chassis** optionally incorporates redundant power modules. The supply, depending on the model, derives its power from an AC power source (100 ~ 240VAC) and/or DC power source (36-60VDC) and/or DC power source (18-36VDC). When two modules are installed, they provide for power redundancy and are hot swappable even during the Line Cards' transmissions. The Line Cards provide all copper and fiber interface connections on the face of each Line Card, along with status indicator LEDs. The status LED indicators provide for quick indications of both copper and fiber link statuses and fault detection.

1.2 Chassis Front Description

The front of the **8-Slot Chassis** contains the line card slots. They are numbered 1 through 8. The typical configuration is with one NMC (**Network Management Controller**) card in slot number 1 and in-band manageable line cards in any other slot numbered 2 through 8.

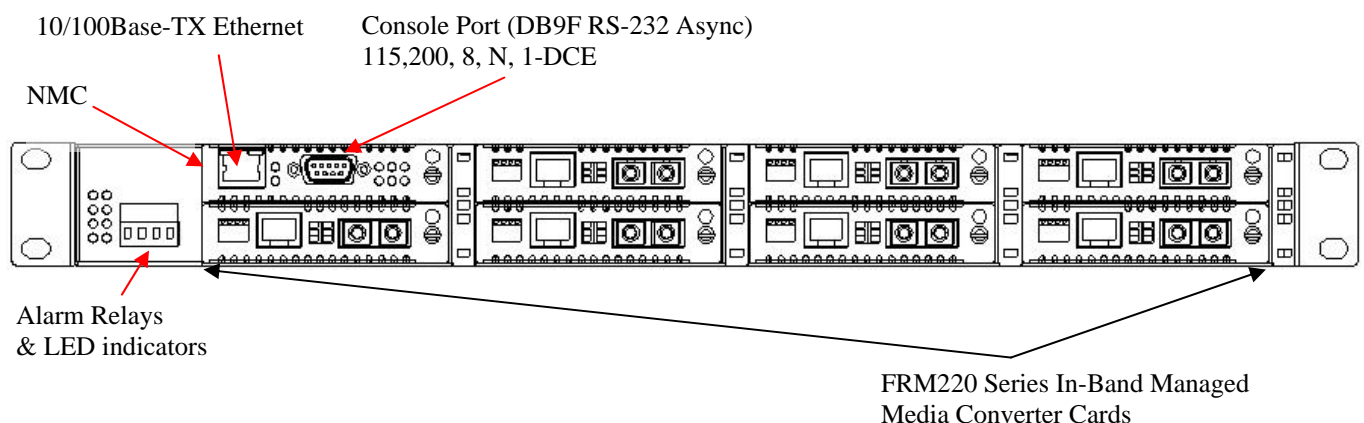

Figure 1-1 Chassis Front View

1.3 LED Indicators and Alarm Relay

LED	Color	Indication
PWR 1	Green	When On, indicates good power from module #1
PWR 2	Green	When On, indicates good power from module #2
FAN a	Green	When On, left fan of power module is OK
FAN b	Green	When On, right fan of power module is OK
ALM 1	Red	When On, NMC has set Alarm 1 ON, relay 1 is closed
ALM 2	Red	When On, NMC has set Alarm 2 ON, relay 2 is closed

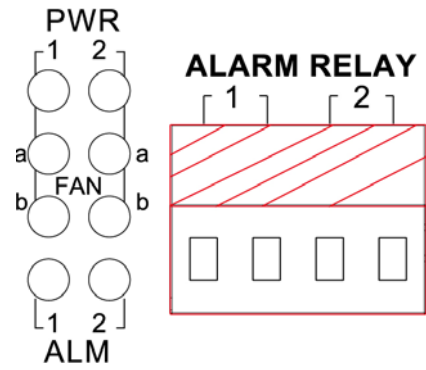

Figure 1-2 Relays and LEDs

1.4 Chassis Rear Description

The rear panel holds the hot-swappable power/fan modules. The pluggable modules do not require any tools for removal or replacement.

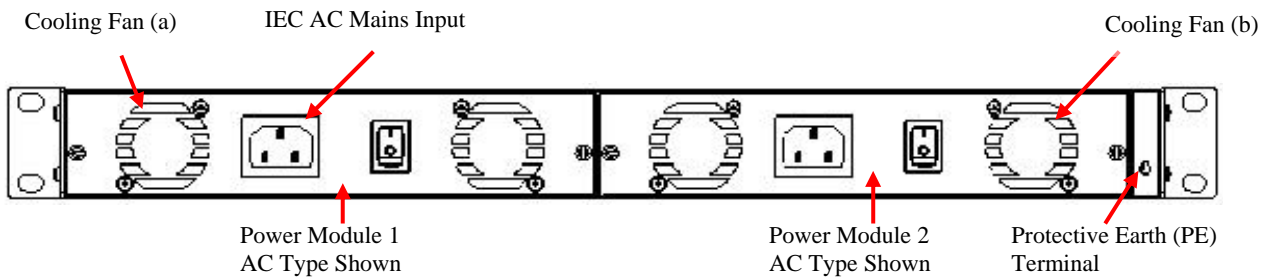

Figure 1-3 Chassis Rear View

1.5 Chassis Physical Dimensions

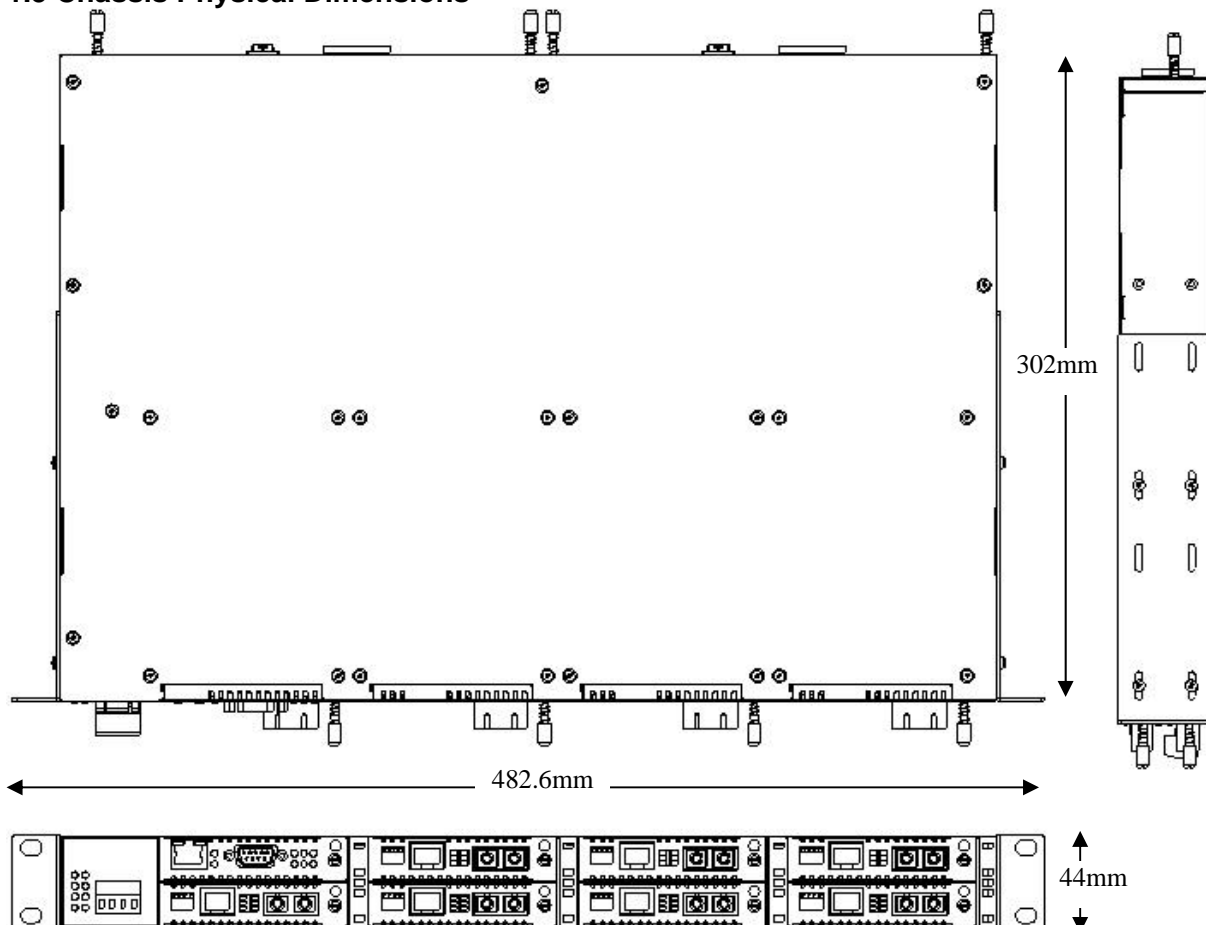

Figure 1-4 Chassis Dimensions, in millimeters

1.6 Chassis Specifications

Environment

Temperature -10 - 50°C Ambient (14-122°F)
Humidity 5-95% non condensing

Alarm relay contact ratings

125VAC 1A
110VDC 0.6A
30VDC 4A

Power Module Specifications

AC Power Module

Input : Universal, 100 ~ 240 ±10% VAC; Frequency : 50/60 Hz ±10%
Output : DC 12V, 200W maximum rating
Connector : C14 (IEC 60320-1)

DC Power Module (two types, DC48 and DC24)

Input : 36 ~ 60 VDC (DC48), 18 ~ 36 VDC (DC24)
Output : DC 12V, 160W (DC48), 128W (DC24) maximum rating
Connector : 3 connector terminal block

AC Power Cord Specification (detachable cord, C13 connector, with national plug per national standards)
6A rated 18AWG (conductors with a minimum cross-section area of 0.75 mm²)

DC Power Cord Specification (wiring must comply with EN 60950-1:2006 standard)
Conductors with a minimum cross-section area of 1mm² (16AWG)

Protective Earth (PE) Specification (wiring must comply with EN 60950-1:2006 standard)
Conductor with a minimum cross-section area of 0.75mm² (18AWG), star washer and non-self-tapping M3.5 screw

Power Consumption

~60 watts (fully loaded chassis, with random mix of line card types)

Heat Generation

~120 BTU (fully loaded chassis, with random mix of line card types)

Compliance

European Union : EN55022:2006, Class A, EN55024:1998+A1:2001+A2:2003, and EN60950-1:2001
FCC : part 15, subpart B, class A

Reliability

MTTB : >65,000 hours (25°C)

Physical Specifications

Dimensions : 438mm (Width) x 302mm (Depth) x 44mm (Height)
(US: 17 1/4" wide x 11 7/8" deep x 1 3/4" high)
Weight : 2.6Kg (US: ~5.75 lbs)

AC module weight : 1050g (US 2.3 lbs)
DC module weight : 930g (US 2 lbs)
NMC card weight : 120g (US 0.25 lbs)

Net Weight : 4.6kgs (US 10 lbs)
(with 1 NMC, 1 AC +1 DC power module & two bracket panels for 19" rack-mounting)

Fully Populated Reference Net Weight: 5.5Kg (US 12 lbs.)
(fully loaded, two powers, NMC and 7 pcs 10/100i line cards)

1.7 NMC (SNMP)

The **FRM220-CH08** must be ordered with an NMC Card. The card is placed in the far left, upper card slot. Management is accomplished either via local control on the asynchronous RS-232 port with an ASCII terminal or via Ethernet and any standard SNMP network management software that supports MIB-II. The WEB GUI based interface provides an easy method for the user to operate and monitor the whole system. Almost all line cards support remote in-band configuration when paired with the same type stand-alone in-band converter.

1.8 Line card options

The **FRM220** is capable of supporting a variety of in-band managed or non-in-band managed line card types which may be mixed and matched in any slot of the rack. See below for a brief of the line cards at the time of this printing. Please refer to the latest version of **FRM220 NMC User Manual** for details of all the line card options for the **FRM220**.

1.8.1 FRM220-10/100i In-band managed 10/100 Fiber Media Converter

The FRM-10/100i (in-band converter) is an In-band Managed (OAM) Fiber Ethernet media converter (MC) that supports 10Base-T or 100Base-TX and converts to 100Base-FX (fiber). The UTP side supports auto-negotiation or forced settings for speed and duplex by setting as well as auto-MDIX. When the FRM-10/100i is placed in the **FRM220** with NMC, the settings are controlled by the chassis management system. The remote FRM-10/100i stand-alone may also be configured from the **FRM220** through the in-band management features (OAM). An optional console manageable single slot chassis, the CH01M, is also available with DB9F connector for stand-alone serial console management.

Features

- Supports Loop Back Test
- Auto-Cross over for MDI/MDIX in TP port
- Supports far end fault (FEF) function via OAM
- Auto-Negotiation or Manual mode in TP port
- Supports link fault pass through (LFP) function
- Bandwidth control (32K or 512Kbps x N)
- Forward 2046 bytes (max.) packets in switch mode
- Forward 9K jumbo packets in converter mode
- Supports forwarding mode option
- Store and forward (switch) mode, Convert mode (small latency)
- Supports local or remote In-band management (Monitor and Configure status) by the SNMP manager in FRM220
- Supports remote CPE power fail detection (Dying gasp)
- Provides Auto Laser Shutdown (ALS) function
- Supports Fiber Hardware Reset (FHR) function
- Provides fiber transceiver information for management
- Supports On-Line In-band F/W upgrade (local or remote) by the SNMP manager in FRM220

Specifications

Complies with IEEE 802.3 and IEEE 802.3u
 288kb packet buffer in switch mode
 1K MAC address table in switch mode
 Supports IEEE802.3x flow control in switch mode
 OAM is based on TS-1000 protocol

10Base-T UTP Cable Requirement

Cable type: Category 3, 4 or 5. Maximum distance: 100 meters (328 feet)

100Base-TX UTP Cable Requirement

Cable type: Category 5, minimum. Maximum distance: 100 meters (328 feet)

Management

The 10/100i line card is managed by an on-card CPU when installed in the FRM220 CH08 chassis. **There are no DIP switches or manual settings.** If the MC is placed stand-alone, without local or remote connection to FRM220 NMC management, the MC runs with default parameter. The default parameters are: switch mode, auto-negotiation, LFP disabled, ALS (Auto Laser Shutdown) disabled, and no bandwidth limit. An optional console manageable single slot chassis, the CH01M, is available with DB9F connector for stand-alone serial console management.

This product includes the following models:

- FRM220-10/100i (1 electrical plus 1 Fixed transceiver media converter)
- FRM220-10/100iS (1 electrical plus 1 SFP media converter)

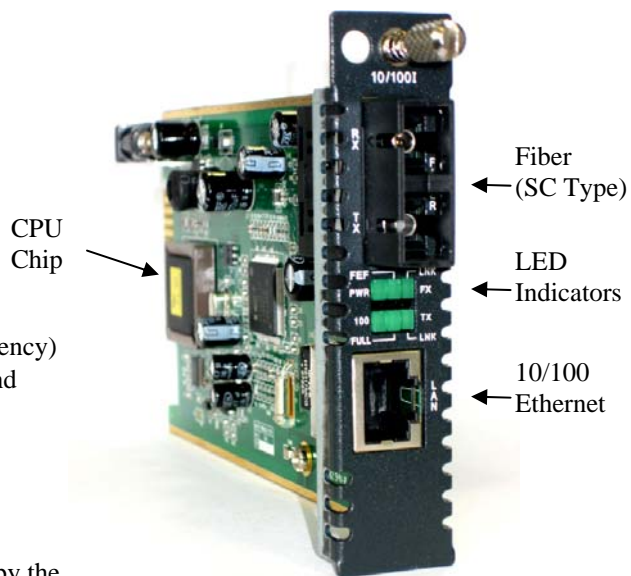

10/100i is a media converter that must be placed in FRM220-CH20 for management. It utilizes fixed transceiver for 100Base-FX fiber connection and one 10/100 Ethernet electrical port.

1.8.2 FRM220-10/100iS-2 Dual Channel In-band managed 10/100 Fiber Media Converter

The FRM-10/100iS-2 (in-band converter) is a Dual Channel (2 converters in 1 card) In-band Managed (OAM) Fiber Ethernet media converter (MC) that supports 10Base-T or 100Base-TX and converts to 100Base-FX (fiber). The UTP side supports auto-negotiation or forced settings for speed and duplex by setting as well as auto-MDIX. When the FRM-10/100iS-2 is placed in the **FRM220** with NMC, the settings are controlled by the chassis management system. The remote FRM-10/100i stand-alone may also be configured from the **FRM220** through the in-band management features (OAM).

Features

- Dual Converter on a single card (2 independent channels)
- Supports Loop Back Test
- Auto-Cross over for MDI/MDIX in TP port
- Supports far end fault (FEF) function via OAM
- Auto-Negotiation or Manual mode in TP port
- Supports link fault pass through (LFP) function
- Bandwidth control (32K or 512Kbps x N)
- Forward 2046 bytes (max.) packets in switch mode
- Forward 9K jumbo packets in converter mode
- Supports forwarding mode option
- Store and forward (switch) mode, Convert mode (small latency)
- Supports local or remote In-band management (Monitor and Configure status) by the SNMP manager in FRM220
- Supports remote CPE power fail detection (Dying gasp)
- Provides Auto Laser Shutdown (ALS) function
- Supports Fiber Hardware Reset (FHR) function
- Provides fiber transceiver information for management
- Supports On-Line In-band F/W upgrade (local or remote) by the
- SNMP manager in FRM220

Specifications

Complies with IEEE 802.3 and IEEE 802.3u
 288kb packet buffer in switch mode
 1K MAC address table in switch mode
 Supports IEEE802.3x flow control in switch mode
 OAM is based on TS-1000 protocol
Compliance: FCC part 15, Subpart B, Class A,
 ANSI C63.4:2003
 CE EN55022:2006, Class A
 EN55024:1998+A1:2001+A2:2003
 LVD: EN60950-1:2001
 MTBF: 65,000 h (25°C)

10Base-T UTP Cable Requirement

Cable type: Category 3, 4 or 5. Maximum distance: 100 meters (328 feet)

100Base-TX UTP Cable Requirement

Cable type: Category 5, minimum. Maximum distance: 100 meters (328 feet)

Management

The 10/100iS-2 card is managed by an on-card CPU when installed in the FRM220 CH08 chassis. **There are no DIP switches or manual settings.** If the MC is placed stand-alone, without local or remote connection to FRM220 NMC management, the two separate MC run with default parameters. The default parameters are: switch mode, auto-negotiation, LFP disabled, ALS (Auto Laser Shutdown) disabled, and no bandwidth limit. When a fully populated CH20 (with 19 10/100iS-2) is deployed, a total of 38 loops are available from the 2U FRM220-CH20. Due to dimension limitations, the 10/100iS-2 is only available for SFP based fiber optics.

This product includes the following models:

- FRM220-10/100iS-2 (2 electrical plus 2 SFP Dual media converter)

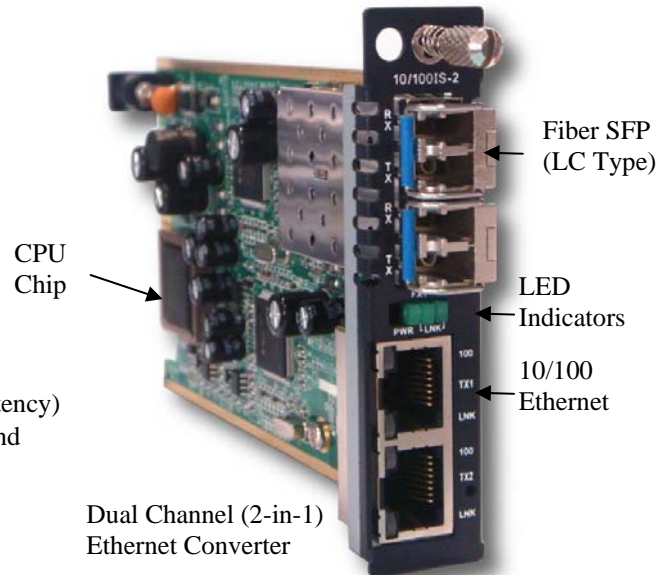

10/100iS-2 is a dual channel media converter that must be placed in FRM220-CH08 for management. It utilizes SFP for fiber connection and two 10/100 Ethernet electrical ports.

1.8.3 FRM220-10/100i-2E In-band managed 10/100 Fiber Media Converter

The FRM-10/100i-2E (in-band converter) is an In-band Managed (OAM) Fiber Ethernet media converter (MC) that supports 2 Ethernet channels of 10Base-T or 100Base-TX and converts to 100Base-FX (fiber). The UTP ports support auto-negotiation or forced settings for speed and duplex by setting as well as auto-MDIX. When the FRM-10/100i-2E is placed in the **FRM220** with NMC, the settings are controlled by the chassis management system. The remote FRM-10/100i-2E stand-alone may also be configured from the **FRM220** through the in-band management features (OAM). An optional console manageable single slot chassis, the CH01M, is also available with DB9F connector for stand-alone serial console management.

Features

- Supports Loop Back Test
- Auto-Cross over for MDI/MDIX in TP port
- Supports far end fault (FEF) function via OAM
- Auto-Negotiation or Manual mode in TP port
- Supports link fault pass through (LFP) function
- Bandwidth control (32K or 512Kbps x N)
- Forward 2046 bytes (max.) packets in switch mode
- Forward 9K jumbo packets in converter mode**
- Supports forwarding mode option
- Store and forward (switch) mode, Convert mode (small latency)
- Supports local or remote In-band management (Monitor and Configure status) by the SNMP manager in FRM220
- Supports remote CPE power fail detection (Dying gasp)
- Provides Auto Laser Shutdown (ALS) function
- Supports Fiber Hardware Reset (FHR) function
- Provides fiber transceiver information for management
- Supports On-Line In-band F/W upgrade (local or remote) by the SNMP manager in FRM220

**When in converter mode, port 3 is disabled and only Fiber port 1 and UTP port 2 are active.

Specifications

Complies with IEEE 802.3 and IEEE 802.3u
 288kb packet buffer in switch mode
 1K MAC address table in switch mode
 Supports IEEE802.3x flow control in switch mode
 OAM is based on TS-1000 protocol

10Base-T UTP Cable Requirement

Cable type: Category 3, 4 or 5. Maximum distance: 100 meters (328 feet)

100Base-TX UTP Cable Requirement

Cable type: Category 5, minimum. Maximum distance: 100 meters (328 feet)

Management

The 10/100i-2E line card is managed by an on-card CPU when installed in the FRM220 CH08 chassis. **There are no DIP switches or manual settings.** If the MC is placed stand-alone, without local or remote connection to FRM220 NMC management, the MC runs with default parameter. The default parameters are: switch mode, auto-negotiation, LFP disabled, ALS (Auto Laser Shutdown) disabled, and no bandwidth limit. An optional console manageable single slot chassis, the CH01M, is available with DB9F connector for stand-alone serial console management.

This product includes the following models:

- FRM220-10/100i-2E (2 electrical plus 1 Fixed transceiver media converter)

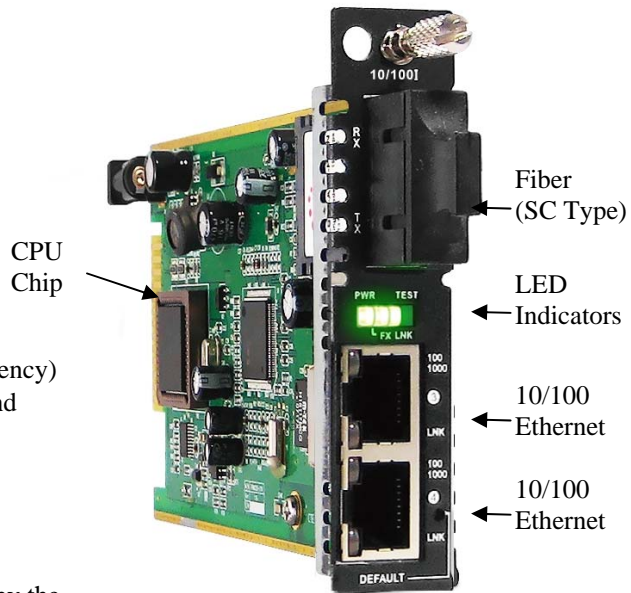

10/100i-2E is a media converter that must be placed in FRM220-CH20 for management.

It utilizes fixed transceiver for 100Base-FX fiber connection and two 10/100 Ethernet ports.

1.8.4 FRM220-10/100A(S) 802.3ah In-band managed 10/100 Fiber Media Converter

This IEEE802.3ah OAM compliant copper to fiber Fast Ethernet solution is designed to make conversion between 10/100Base-TX and 100Base-FX with SC or ST connector. With SNMP agent and GUI Web-based management in the FRM220, the Network administrator can monitor, configure and control the activity of each 802.3ah series line card. This 802.3ah OAM Compliant media converter, with its Q-in-Q and maximum interoperability will enable carriers and service providers to have a clear vision of their network and conveniently manage their demarcation point.

Features

- 10/100Mbps auto-negotiation or forced mode operation on the TP interface
- Fiber 100Mbps/Full
- Supports Flow control function
- Supports OAM remote loopback to assist in diagnosing network problems
- Supports bandwidth control
- Supports Dying Gasp Reporting for power outage
- Supports QoS Classification
- Supports local / remote monitor
- Supports local / remote Configuration
- Supports Q in Q double tagged frame transparent
- Supports remote firmware upgrade
- Supports IEEE 802.1q Tag VLAN pass thru
- Compatible with FRM220 Managed Chassis

LAN Interface Specification

One RJ-45 female connector for straight or cross-over connection.

Supports 10/100Base-TX, n-way (Auto-Negotiation).

Transmission Packet Rate for 10Base-T: 14880 per second

100Base-TX: 148800 per second

Copper TP cable 4 pair Cat. 3 4, 5e or 6 UTP

Optical Interface Specification

Transceiver Connector type : ST or SC, or LC with SFP

Supports Full 100Mbps speed

Supports auto-receive sensitivity function, no extra attenuators needed.

General Specification

IEEE 802.3ah In-band OAM management compliant

6 diagnostic LEDs : Power/FX-Link ,TX-Speed/TX-Duplex/TX-Link/Test (loopback)

Temperature: 0 - 50° C (Operating); 0 - 70° C (Storage).

Humidity: 20-80% non-condensing (Operating); 10-90% (Storage).

Power: DC Jack : Switching adaptor (12V, 400mA)

Consumption: < 4W

Dimensions: 155mm x 88mm x 23mm (LxWxH).

Weight: 120g.

Compliance: FCC part 15, Subpart B, Class A,

ANSI C63.4:2003

CE EN55022:2006, Class A

EN55024:1998+A1:2001+A2:2003

LVD: EN60950-1:2001

MTBF: 65,000 h (25°C)

This product includes the following models:

- FRM220-10/100AS-2 (2 electrical plus 2 SFP 4-port fiber switch)
- FRM220-10/100A (2 electrical plus 1 fixed transceiver 3 port fiber switch)



10/100AS-2 is a stand-alone manageable 4 port Fast Ethernet fiber switch, utilizing SFP for 100Base-FX fiber connection and two 10/100 Ethernet electrical ports.

1.8.5 FRM220-1000EA(S) 802.3ah In-band managed Gigabit Fiber Media Converter

This IEEE802.3ah OAM compliant copper to fiber Gigabit Ethernet solution is designed to make conversion between 10/100/1000Base-TX and 1000Base-SX/LX with SFP-LC connector. With SNMP agent and GUI Web-based management in the FRM220, the Network administrator can monitor, configure and control the activity of each 802.3ah series line card. This 802.3ah OAM Compliant media converter, with its Q-in-Q and maximum interoperability will enable carriers and service provider to have a clear vision of their network and conveniently manage their demarcation point.

Features

- 802.3ah In-band OAM management compliant
- 2 ports 10/100/1000Base-T and 2 ports GbE fiber (SFP)
- Supports Flow control function
- Supports OAM remote loopback
- Supports spanning tree function
- Supports bandwidth control
- Supports Dying Gasp Reporting for power outage
- Supports local / remote monitor
- Supports local / remote Configuration
- Supports Q in Q double tagged frame transparent
- Supports remote F/W upgrade (In-band)
- Supports IEEE 802.1q Tag VLAN pass thru and port-base VLAN
- Provides fiber transceiver information for management
- Compatible with FRM220 Managed Chassis

LAN Interface Specification

Two RJ-45 female connectors for straight or cross-over connection.
 Supports 2-port 10/100/1000Base, n-way (Auto-Negotiation).
 Supports Full, Half duplex, 10/100/1000 speed force mode selections.
 Transmission Packet Rate for 10Base-T: 14880 per second
 100Base-TX: 148800 per second ; 1000Base-T: 1488000 per second
 Copper TP cable 4 pair Cat. 5e or 6 UTP

Optical Interface Specification

Transceiver Connector type : SFP-LC
 Supports 2-port, 1000Mbps SFP slot
 Supports auto-receive sensitivity function, no extra attenuators needed.

General Specification

Standards IEEE 802.3 10Base-T,
 IEEE 802.3u 100Base-TX , 100Base-FX,
 IEEE 802.3ab, 802.3z 1000Base-T, 1000Base-SX/LX
 IEEE 802.3ah In-band OAM management compliant
 6 diagnostic LEDs : Power / FX-Link ,TX-Speed / TX-Duplex/ TX-Link / Test (loopback)
 Temperature: -10 - 60° C (Operating);-20 - 70° C (Storage).
 Humidity: 0-95% non-condensing (Operating); 10-90% (Storage).
 Power: DC Jack : Switching adaptor (12V, 1A)
 Consumption: < 12W
 Dimensions: 155mm x 88mm x 23mm (LxWxH).
 Weight: 120g.

Compliance: FCC part 15, Subpart B, Class A,
 ANSI C63.4:2003
 CE EN55022:2006, Class A
 EN55024:1998+A1:2001+A2:2003
 LVD: EN60950-1:2001
 MTBF: 65,000 h (25°C)

This product includes the following models:

- 1000EAS (2 electrical plus 2 SFP)
- 1000EAS-1 (1 electrical plus 1 SFP)
- 1000EA-1 (1 electrical plus 1 fixed fiber)
- 1000EAS-2F (2 SFP)

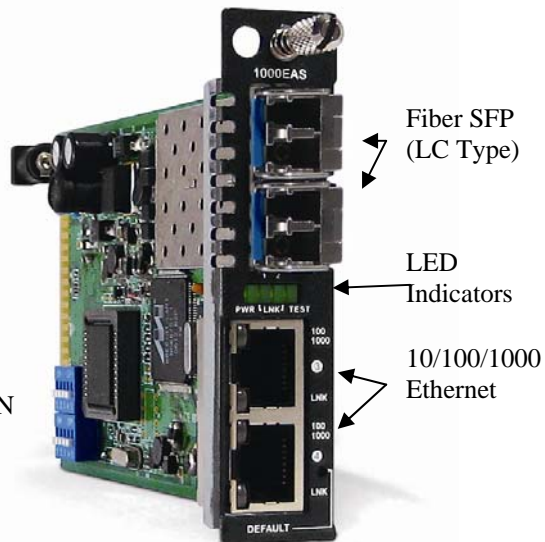

1000EAS is a stand-alone manageable 4 port Gigabit Ethernet fiber switch, utilizing SFP for 1000Base-SX/LX fiber connections and two 10/100/1000 Ethernet electrical ports.

1.8.6 FRM220-1000EDS Managed Gigabit Fiber Media Converter

The FRM220-1000EDS is a 4-port switch or dual channel (two in one) copper to fiber Gigabit Ethernet solution designed to make conversion between 10/100/1000Base-TX and 1000Base-SX/LX with SFP transceivers. With SNMP and Web-based management in the FRM220, the Network administrator can monitor, configure and control the activity of each card in the chassis. This converter also supports features such as ingress/egress bandwidth control, auto or forced mode setting for copper Ethernet as well as auto laser shutdown. The FRM220-1000E(s)-1 is a single copper to single fiber Gigabit Ethernet solution designed to make conversion between 10/100/1000Base-TX and 1000Base-SX/LX with SC or SFP LC connector.

Features

- 2-port 10/100/1000Base-T to 2-port 1000Base-SX/LX (EDS)
- 1-port 10/100/1000Base-T to 1 port 1000Base-SX/LX (ES-1)
- Supports dual converter mode or switch mode
- Auto-negotiation or forced mode
- Auto MDI/MDIX
- Forward 2046 bytes (Max.) packets
- Support Bandwidth Control (70k ~ 250Mbps)
- Supports Flow control (Pause)
- Support Link fault pass through (LFP) function
- Supports remote CPE power fail detect (dying gasp)
- Auto Laser Shutdown (ALS)
- Online local f/w upgrade

1000EDS is a manageable 4 port Gigabit Ethernet fiber switch when placed in the FRM220-CH20 or by DIP switches if used stand-alone. It utilizes SFP for 1000Base-SX/LX fiber connection and two 10/100/1000 Ethernet electrical ports.

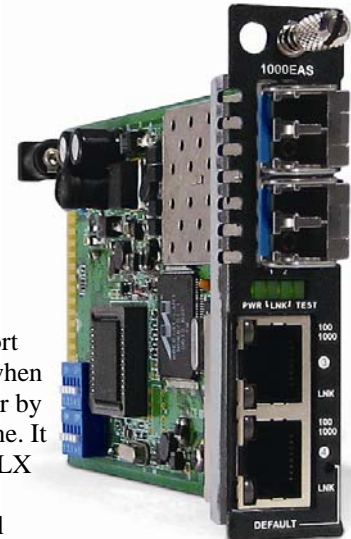

Specifications

Ports	Optical Interface Connector : SFP LC Data rate : 1000Mbps Duplex mode : Full duplex Cable type : MM 62.2/125µm, 50/125µm. SM 9/125µm Distance : MM 2km, SM 15/30/50/80/120km, WDM 20/40/60/80km Wavelength: 1310nm, 1550nm,
	Electrical Interface Connector : RJ45 Data rate : 10Mbps, 100Mbps, 1000Mbps Duplex mode: Half / Full duplex Cable type: 10Base-T Cat.3, 4, 5, UTP, 100Base-TX Cat.5, 5e, 1000Base-T Cat. 5e or higher Distance: 100 meters
Standards	IEEE 802.3, IEEE 802.3u, IEEE802.3ab, IEEE802.3z
LEDs	Power, FX-Link 1/2, 2Ch, TX-Link, TX-SPD
Power	DC In 12V
Power Consumption	< 5W
Dimension (D x W x H) mm	155 x 88 x 23mm
Weight	120g
Temperature	-10~60° C (Operating) , -20~70° C (Storage)
Humidity	10~95% non-condensing
Certification	CE LVD/EMI, FCC, RoHS
MTBF	65,000 h (25° C)

This product includes the following models:

- 1000EDS (2 electrical plus 2 SFP)
- 1000ES (1 electrical plus 1 SFP)
- 1000E (1 electrical plus 1 fixed optical)

1.8.7 FRM220-E1/T1 In-band managed G.703 E1/T1(DS1) Fiber Modem

The FRM220-E1/T1 is a fiber modem transport for G.703 E1 or T1(DS1) transmission. The BNC model (E1 only) provides unbalanced 75 Ohm coaxial connections while the RJ-45 model provides balanced 100/120 Ohm connections over twisted pair wiring. When the FRM220-E1/T1 card is placed in the FRM220 rack with in-band management, the card status, type, version, fiber link status, E1 or T1 link status and alarms can all be displayed. Configuration is also available to enable or disable the port, reset the port, do far end fault setting, and initiate local or far end loop-back tests. When configured in G.703 E1 mode, this model also supports fractional E1 (G.704) as well as remote connection to FRM220-Data (V.35, RS-530/449, X.21) fiber modem for either unframed (2048Kbps) or fractional (nx64kbps where n=1 to 31) transmissions.

Features

- Network Management via Terminal or SNMP in FRM220 chassis
- T1/E1 RJ-45 (USOC RJ-48C) or Coax (BNC) Fiber Modem
- Supports AMI or B8ZS/HDB3 line codes
- Unframed (transparent clear channel) mode
- N x 64K (fractional E1) mode
- Supports point to point (CPE) solution with FRM220-DATA
- User selectable Loop back tests
- Far End Fault (FEF) detection

E1/T1 is a stand-alone manageable G.703 E1/DS1(T1) Fiber Optical Modem that can carry E1/T1 over fiber transparently or with framing. One model is designed with RJ-45, while another model supports E1 via coaxial BNC connections.

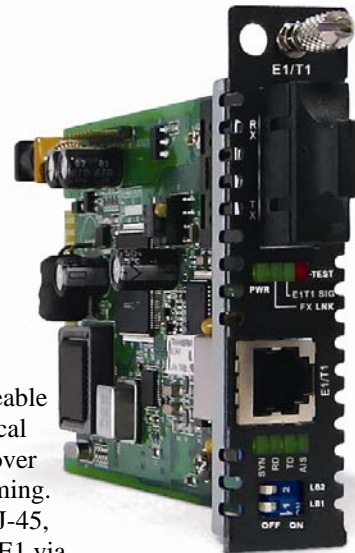

Specifications

<i>Ports</i>	Connector	1x9 (SC, ST, FC) or SFP LC
<i>Optical Interface</i>	Cable type	MM 62.2/125μm, 50/125μm. SM 9/125μm
	Cable length	MM 2km, SM 15/30/50/80/120km, WDM 20/40/60/80km
	Wavelength	MM 1310nm, SM 1310, 1550nm, WDM 1310Tx/1550Rx(type A), 1550Tx/1310Rx(type B)
	Data rate	36.864Mbps
<i>Electrical Interface</i>	Connector	RJ45 E1-120ohm, T1-100ohm, BNC E1-75ohm
	Data rate	E1: 2.048Mbps, T1:1.544Mbps
	Line Code	E1 HDB3/AMI, T1 B8ZS/AMI
	Cable type	Cat.3 or higher Twisted-Pair cable
<i>Standards</i>		E1 ITU-T G.703, G.704, G.706, G.732, G.823 T1 ITU-T G.703, G.704, AT&T, TR-62411, ANSI T1.403
<i>LEDs</i>		Power, FX-Link, E1/T1 SIG, Test, SYN, RD, TD, AIS
<i>Power</i>		DC In 12V
<i>Consumption</i>		< 5W
<i>Dimensions</i>		155 x 88 x 23mm (D x W x H)mm
<i>Weight</i>		120g
<i>Temperature</i>		-10~60°C (Operating) , -20~70°C (Storage)
<i>Humidity</i>		10~95% non-condensing
<i>Certification</i>		CE, FCC, LVD, RoHS
<i>MTBF</i>		65,000 h (25°C)

This product includes the following models:

- E1/T1R (RJ-45 electrical plus fixed optical)
- E1T1RS (RJ-45 electrical plus SFP)
- E1B (Dual BNC plus fixed optical)
- E1BS (Dual BNC plus SFP)

1.8.8 FRM220-Data In-band managed V.35, X.21, RS-530/449/232 Fiber Modem

The FRM220-DATA is a fiber modem for high-speed (up to 8.192Mbps) synchronous or low speed synchronous and asynchronous data transmissions (V.35, RS-232, RS-530, X.21 or RS-449) over fiber optical media. When the FRM220-DATA card is placed in the FRM220 rack with SNMP management, in-band management allows viewing the card and remote modem's status, type, version, fiber link status, data link status and alarms. Both card and remote can be configured to enable or disable the port, reset the port, set the data rate, modify the clock mode, and initiate local or far end loop back tests. The FRM220-Data Fiber Modem may also be paired with the FRM220-E1/T1 for Nx64K transmissions.

Features

- Synchronous or Asynchronous data over fiber
- In-band network management
- Manage via terminal, web or SNMP in FRM220-CH20 chassis
- Software selectable interface, V.35, X.21, RS530, RS449, RS232
- Software selectable DCE or DTE mode
- User selectable data rate n x 64kbps, up to 9Mbps
- Independent clock mode setting
- TC RC clock (internal, external, or recovery)
- Electrical and optical loop back tests
- Compatible with FRM220-E1 on same fiber link for N x 64k
- Stand-Alone Console management with CH01M single slot chassis

Specifications

Ports

Optical Interface

Connector : 1x9 (SC, ST, FC) or SFP LC

Data rate : 36.864Mbps

Line coding: Scrambled NRZ

Bit Error Rate: Less than 10⁻¹⁰

Cable type : MM 62.2/125μm, 50/125μm. SM 9/125μm

Distance : MM 2km, SM 15/30/50/80/120km, WDM 20/40/60/80km

Wavelength: 1310nm, 1550nm,

Electrical Interface

Connector : HDB26F w/ adapter cable for V35, X21, RS530, RS449, RS232

Line Code: NRZ

Baud Rate: RS-232 up to 384K sync and async

V.35/RS-530 up to 9152k sync, async up to 2048k

N*64Kbps , where n=1 to 143 (64K ~ 9152Kbps)

Receive and Transmit Clock source :Internal, Recovery, External

ITU-T

Power, FX Link, RTS, Test , TD, RD, CTS, DCD

DC In 12V

Standards

LEDs

Power

Power Consumption

Dimension (D x W x H) mm

Weight

Temperature

Humidity

Certification

MTBF

< 5W

155 x 88 x 23mm

120g

-10~60° C (Operating) , -20~70° C (Storage)

10~95% non-condensing

CE LVD/EMI, FCC, RoHS

65,000 h (25° C)



This product includes the following models:

- FRM220-Data/XXX (Fiber Modem with fixed optical and adapter cable)
- FFRM220-DataS/XXX (Fiber Modem with SFP and adapter cable)

Where XXX equals:

232 for RS-232 cable (DB25F)

530 for RS-530 cable (DB25F)

V35 for V.35 cable (MB34F)

X21 for X.21 cable (DB15F)

449 for RS-449 cable (DB37F)

1.8.9 FRM220-Serial/485 In-band managed RS-485/422/232 Fiber Modem

The FRM220-Serial/485 provides an Asynchronous Fiber Modem solution to extend RS-485 or RS-232 transmission distance up to 2km over multimode fiber or up to 120km over single mode fiber. The modem is equipped with multiple interface circuits for connection to RS-232 or RS-485/422 (2 or 4 wire, full or half duplex). The FRM220-Serial/485 secures data transmission over EMI resistant fiber at speeds up to 460kbps for RS-232 or up to 1024kbps for RS-485/422. When the FRM220-Serial/485 card modem is placed in the FRM220 rack with SNMP management, in-band management allows viewing the card and remote modem's status, type, version, fiber link status, data link status and alarms. Both card and remote can be configured to enable or disable the port, reset the port and set the interface type.

Features

- Extend asynchronous serial transmission from 2km to 120km over fiber
- In-band network management
- Manage via terminal, web or SNMP in FRM220-CH20 chassis
- Software selectable data interface for RS232/ 422/ 485
- Software selectable two wires (half duplex) or four wires (full duplex) RS485
- Software selectable three or five wires RS232
- Speeds up to 460kbps for RS232 (Async. mode)
- Speeds up to 1Mbps for RS485/ 422 (Async)

Specifications

Ports

Optical Interface

Connector : 1x9 (SC, ST, FC) or SFP LC

Data rate : 36.864Mbps

Line coding: Scrambled NRZ

Bit Error Rate: Less than 10^{-10}

Cable type : MM 62.2/125 μ m, 50/125 μ m. SM 9/125 μ m

Distance : MM 2km, SM 15/30/50/80/120km, WDM 20/40/60/80km

Wavelength: 1310nm, 1550nm,

Electrical Interface

Connector : 6 pins Terminal block

Data Signal Formats

RS485 2-wire

RS422 4-wire

RS232 RTS/CTS 5-wire

RS232 3-wire

Baud Rate:

RS422, RS485 up to 1024kbps

RS232 up to 256kbps

Standard EIA/TIA RS485, RS422, RS232

LEDs Power, FX Link, DI, DO, Test

Power DC In 12V

Power Consumption < 5W

Dimension (D x W x H) mm 155 x 88 x 23mm

Weight 120g

Temperature -10~60° C (Operating) ,-20~70° C (Storage)

Humidity 10~95% non-condensing

Certification CE LVD/EMI, FCC, RoHS

MTBF 65,000 h (25° C)



This product includes the following models:

- FRM220-Serial/485 (6 pin terminal block and fixed fiber transceiver)
- FRM220-Serial/485S (6 pin terminal block with SFP)

1.8.10 FRM220-FXO/FXS In-band managed POTS (Voice) over Fiber Modem

FRM220-FXO/FXS POTS phone line converter extender is used to connect PSTN voice signals to distant Plain Old Telephone (POTS) devices. FRM220-FXO/FXS provides a fiber media transport for POTS transmission and features an RJ-11C for copper connection. A pair of FRM220-FXO/FXS is required to implement an end to end system. FXO mode connects to a telephone line or PBX and has ability to detect ringing voltages and to act as a telephone. FXS mode is the reciprocal unit and has ability to act as PSTN and connects to a telephone device. When the FRM220-FXO/FXS card is placed in the FRM220 rack with SNMP management, in-band management allows viewing the card and remote converter's status, type, version, fiber link status, on hook status and alarms. Both card and remote can be configured to enable or disable the port, reset the port and set the FXO or FXS mode.

Features

- Extend telephone voice transmission from 2km to 120km over fiber
- Management via terminal, web or SNMP in FRM220-CH20 chassis
- Manage stand-alone via DIP Switch
- Supports telephone voice transmission
- Supports caller ID pass through
- Selectable FXO or FXS mode
- Supports FXS to FXS hot line

Specifications

Ports

Optical Interface

Connector : 1x9 (SC, ST, FC) or SFP LC

Cable type : MM 62.2/125 μ m, 50/125 μ m. SM 9/125 μ m

Distance : MM 2km, SM 15/30/50/80/120km, WDM 20/40/60/80km

Wavelength: 1310nm, 1550nm,

Electrical Interface

Connector : RJ-11

FXO mode

Impedance : 600 ohms

Coding : 16 bits liner

Loop Current : 10~100mA

Ring Frequency : Acceptable 20 ~50Hz

Insertion Loss: 0.0 \pm 1.0dB at 1000Hz

FXS mode

Impedance : 600 ohms

Coding : 16 bits liner

Dial: DTMF and Dial Paul

Battery Source: 48VDC \pm 4V

Ringing Waveform : Sine wave

Ringing Frequency : 20/25/30/50 Hz selectable

Ring Cadence: FXS to FXS : On / 1 sec, Off / 2 sec

FXO to FXS; Reproduces the cadence detected by FXO

Insertion Loss 0.0 \pm 1.0dB at 1000Hz

REN: 4.0B(Ring Equivalence Number)

Power, FX Link, Phone Act, Test

DC In 12V

< 5W

155 x 88 x 23mm

120g

-10~60 $^{\circ}$ C (Operating) ,-20~70 $^{\circ}$ C (Storage)

10~95% non-condensing

CE LVD/EMI, FCC, RoHS

65,000 h (25 $^{\circ}$ C)

LEDs

Power

Power Consumption

Dimension (D x W x H) mm

Weight

Temperature

Humidity

Certification

MTBF



This product includes the following models:

- FRM220-FXO/FXS (POTS over Fiber fixed transceiver)
- FRM220-FXO/FXS-S (POTS over Fiber SFP)

1.8.11 FRM220-155MS SM/MM, MM/SM converter / repeater

The FRM220-155MS is a fiber to fiber optical media converter and repeater that allows data rates up to 155Mbps. FRM220-155MS supports 2R regeneration, which consists of re-amplification and reshaping. This converter is compatible with fiber interfaces such as 100Mbps Fast Ethernet, 155Mbps STM1 and OC3. The FRM220-155MS works well with FRM220-CH20 chassis as slide-in card or with FRM220-CH01, one slot chassis as a stand-alone fiber converter. When the FRM220-155MS card is placed in the FRM220 rack with SNMP management, the management can view the converter card's status, type, version, fiber link status and alarms. The card can be configured to enable or disable the port, reset the port or enable/disable Auto Laser Shutdown.

Features

- Transparent fiber media converter / repeater
- Speed up to 155Mbps (Fast Ethernet, OC3, STM-1)
- Manage via terminal, web or SNMP in FRM220-CH20 chassis
- Extend transmission from 2km to 120km over fiber
- Perform optical repeater function (Re-amplification & Reshaping)
- Supports Client / Line loop back test
- Link Fault Pass through (LFP)
- Auto Laser Shutdown (ALS)



Specifications

Ports

Optical Interface

Connector : 1x9 (SC, ST, FC) or SFP LC
 Data rate: Up to 155Mbps (Fast Ethernet, OC3, STM-1)
 Regeneration type: 2R
 Loop back: Line/Client
 Cable type : MM 62.2/125 μ m, 50/125 μ m. SM 9/125 μ m
 Wavelength:1310nm, 1550nm,
 Power, Line Link, Client Link, Test
 DC In 12V

LEDs	Power, Line Link, Client Link, Test
Power	DC In 12V
Power Consumption	< 5W
Dimension (D x W x H) mm	155 x 88 x 23mm
Weight	120g
Temperature	-10~60° C (Operating) ,-20~70° C (Storage)
Humidity	10~95% non-condensing
Certification	CE LVD/EMI, FCC, RoHS
MTBF	65,000 h (25° C)

This product includes the following models:

- FRM220-155MS (STM-1 Fiber Repeater with fixed transceivers)
- FRM220-155MS-SFP (STM-1 Fiber Repeater with SFP)

1.8.12 FRM220-2.7G-2S, 2.7Gbps 3R Fiber Transponder

The FRM220-2.7G-2S is an optical 3R regeneration device, which provides re-amplification, reshaping and retiming. The transponder card converts a data signal to the correct wavelength for transmission on a specific channel by supporting SFP optics on both line side and client side interfaces. When the FRM220-2.7G-2S 3R card is placed in the FRM220 rack with SNMP management, the management can view the converter card's status, type, version, fiber link status and alarms. The card can be configured to enable or disable the port, reset the port and set the desired data rate.

Features

- Protocol transparent fiber media converter / repeater
- Up to 2.7Gbps
- Clocking for Fast Ethernet, OC3, STM-1, STM-4, STM-16, FC-1, FC-2
- Network management via terminal, web or SNMP in FRM220-CH20 chassis
- Extend transmission from 2km to 120km over fiber
- Perform 3R optical repeater function (Re-amplification & Reshaping, Re-clocking)
- Supports Client / Line loop back test
- Link Fault Pass through (LFP)
- Auto Laser Shutdown (ALS)
- Serial console for stand-alone management
When used with CH02M two slot chassis

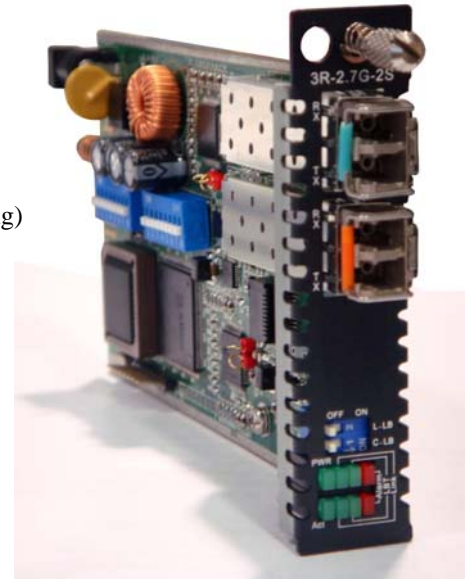

Specifications

Ports

Optical Interface

Connector : LC (SFP)

Data rate: Up to 2.7Gbps

Fixed rates for:

E3 (34.368M)

DS3/T3 (44.736M)

OC1/STM-0 (51.84M)

Fast Ethernet (125M)

STM-1/OC3 (155.52M)

STM-4/OC12 (622.080M)

STM-16/OC48 (2,488.32M)

FC-1 (1.0625G)

FC-2 (2.125G)

Regeneration type: 3R

Loop back: Line/Client

Cable type : SM 9/125 μ m, MM 50/125 μ m, 62.2/125 μ m

Wavelength: 850, 1310, 1550nm,

Power, Line Link, Client Link, Test, Alarm

DC In 12V

LEDs

Power

Power Consumption

Dimension (D x W x H) mm

Weight

Temperature

Humidity

Certification

MTBF

< 10W

155 x 88 x 23mm

120g

-10~60° C (Operating) , -20~70° C (Storage)

10~95% non-condensing

CE, FCC, LVD, RoHS

65,000 h (25° C)

1.8.13 FRM220-2.7G-3S 3R Transponder with Protection

The FRM220-2.7G-3S is an optical 3R regeneration device, which provides re-amplification, reshaping and retiming and offers fiber protection. The transponder card converts a data signal to the correct wavelength for transmission on a specific channel by supporting SFP optics on line side to Primary or Secondary interfaces. When the FRM220-2.7G-3S 3R card is placed in the FRM220 rack with SNMP management, the management can view the converter card's status, type, version, fiber link status and alarms. The card can be configured to enable or disable the port, reset the port and set the desired data rate.

Features

- Protocol transparent fiber media converter / repeater
- Supports fiber redundancy by switching Primary to Secondary path
- Programmable receive optical threshold fiber protection
- Up to 2.7Gbps
- Clocking for Fast Ethernet, OC3, STM-1,STM-4, STM-16,FC-1, FC-2
- Network management via terminal, web or SNMP in FRM220-CH20 chassis
- Extend transmission from 2km to 120km over fiber
- Perform 3R optical repeater function (Re-amplification & Reshaping, Re-clocking)
- Supports Line / Primary / Secondary loop back test
- Link Fault Pass through (LFP)
- Auto Laser Shutdown (ALS)
- Serial console for stand-alone management
When used with CH02M two slot chassis

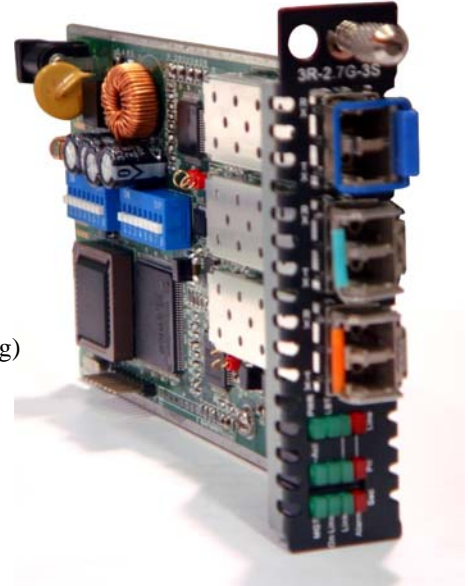

Specifications

Ports

Optical Interface

Connector : LC, 1 Line SFP, 1 Primary SFP, 1 Secondary SFP

Data rate: Up to 2.7Gbps

Fixed rates for:

- E3 (34.368M)
- DS3/T3 (44.736M)
- OC1/STM-0 (51.84M)
- Fast Ethernet (125M)
- STM-1/OC3 (155.52M)
- STM-4/OC12 (622.080M)
- STM-16/OC48 (2,488.32M)
- FC-1 (1.0625G)
- FC-2 (2.125G)

Regeneration type: 3R

Loop back: Line / Primary or Secondary

Cable type : SM 9/125 μ m, MM 50/125 μ m, 62.2/125 μ m

Wavelength: 850, 1310,1550nm,

Power, Line Link, Primary Link, Secondary Link, Test, Alarm

DC In 12V

LEDs

Power

Power Consumption

Dimension (D x W x H) mm

Weight

Temperature

Humidity

Certification

MTBF

< 10W

155 x 88 x 23mm

120g

-10~60° C (Operating) ,-20~70° C (Storage)

10~95% non-condensing

CE, FCC, LVD, RoHS

65,000 h (25° C)

1.8.14 FRM220-10G-xx 10Gbps 3R Fiber Transponder

The FRM220-10G-xx is a series of managed 10G fiber to fiber 3R repeater/transponders. Based on a number of 10 Gigabit Fiber standards, these transponders support XFP to XFP (XX), SFP+ to XFP (SX), or SFP+ to SFP+ (SS) fiber connections. The transponders are protocol transparent, providing 3R regeneration between these different optical module types. One of the major applications for this converter is in connecting proprietary transceiver equipment to CWDM or DWDM when these 'colored' optical modules are not available for the proprietary equipment. With full duplex wire speed forwarding capability between the 2 fiber media, the FRM220-10G-xx brings you the best and simplest solution for your 10G conversion between fiber and fiber.

Features

- Protocol transparent 3R fiber media transponder/repeater
- Supports IEEE802.3ae, 10G Fiber Ethernet
- Supports 10G Fiber Channel, STM-64
- Network management via terminal, web or SNMP in FRM220-CH20 chassis
- Extend 10G Ethernet transmission over fiber
- Useful as a 'Transponder' in CWDM or DWDM systems for 10G Ethernet/Fiber Channel/STM-64
- Supports Client / Line loop back tests
- Serial console for stand-alone management when inserted in CH02M Two Slot Chassis

Specifications

Ports

Optical Interface

FRM220-10G-SS

Connector : LC, 1 Line SFP+, 1 Client SFP+

FRM220-10G-XX

Connector : LC, 1 Line XFP, 1 Client XFP

FRM220-10G-SX

Connector : LC, 1 Line XFP, 1 Client SFP+

Data rates:

- 1G FC (1.0625G)
- 2G FC (2.125G)
- 4G FC (4.25G)
- 8G FC (8.5G)
- 10G FC (10.51875G)
- 10G Base Ethernet (10.3125G)
- STM-64/OC192 (9.95328G)
- OTN G.709 OTU2 (10.709225G)

Loop back: Line/Client

Cable type : SM 9/125μm, MM 50/125μm, 62.2/125μm

Wavelength: 850, 1310, 1550nm,

Power, Line Link, Client Link, Test

DC In 12V

< 8W

Dimension (D x W x H) mm 155 x 88 x 23mm

Weight 120g

Temperature -10~60° C (Operating) , -20~70° C (Storage)

Humidity 10~95% non-condensing

Certification CE, FCC, LVD, RoHS

MTBF 65,000 h (25° C)

LEDs

Power

Power Consumption

Dimension (D x W x H) mm

Weight

Temperature

Humidity

Certification

MTBF

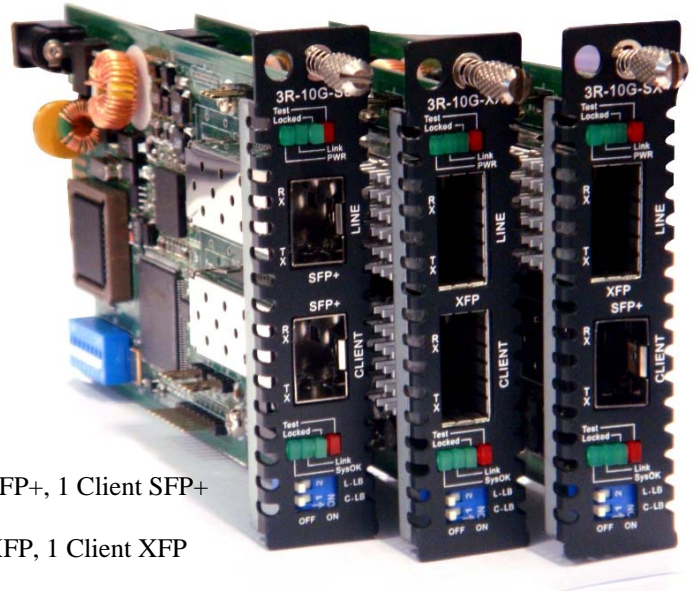

Warning: Due to high power requirements and heat dissipation of 10G Series cards, they are limited to placing a maximum of 10 cards in CH20 chassis leaving an empty space between each card. 10G Series cards should not be placed in CH01 single slot chassis for this same reason. Additionally, only one card should be placed in CH02 with an additional NMC for management.

This product includes the following models:

- FRM220-10G-SS (10G fiber 3R transponder/repeater, SFP+ to SFP+)
- FRM220-10G-XX (10G fiber 3R transponder/repeater, XFP to XFP)
- FRM220-10G-SX (10G fiber 3R transponder/repeater, SFP+ to XFP)

1.8.15 FRM220-MD40/80 CWDM Mux/DeMux

The FRM220-MD40 is 4 channels MUX / DEMUX, modular design card for CWDM wavelengths including 1510nm, 1530nm, 1550nm, 1570nm. The FRM220-MD40-UP02 is 4 channels MUX / DEMUX, modular design card for CWDM wavelengths including 1470nm, 1490nm, 1590nm, 1610nm and two upgrade ports for CWDM wavelength ranges of 1503nm ~ 1577nm and 1260nm ~ 1457nm. The FRM220-MD80-UP01 is 8 channels MUX/DEMUX, modular design card for CWDM wavelengths including 1470nm, 1490nm, 1510nm, 1530nm, 1550nm, 1570, 1590, 1610nm and one upgrade port for CWDM wavelength range of 1260nm ~ 1457nm. The MUX / DEMUX cards provide the primary wave division and combination functions for CWDM. Line side wave lengths require translation to client side equipment via a transponder card.

Features

- Full native mode performance
- Optical connectors : LC / UPC
- Passive model requires no power
- Protocol transparent, no limitation
- Utilizes industry standard ITU CWDM wavelength
- High isolation WDM
- Low insertion loss
- Wide Operation wavelength Range
- Environmentally Stable

Specifications

Connector : LC / UPC

Standard : ITU-T G.694.2 (CWDM grid)

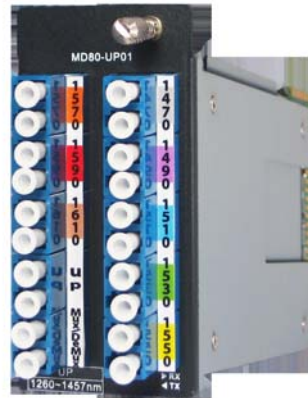

FRM220-MD40 : 4 Wavelength CWDM Mux / DeMux Card

Wavelengths : 1510, 1530, 1550, 1570nm

Insertion Loss : <1.8dB (including connector loss)

Return Loss : >45dB

FRM220-MD40-2UP : 4 Wavelength CWDM Mux / DeMux Card + 2 upgrade ports

Wavelengths : 1470, 1490, 1590, 1610nm

Upgrade port 1 : 1503 ~ 1577nm

Upgrade port 2 : 1260 ~ 1457nm

Upgrade port isolation : >30dB

Insertion Loss : < 2.2dB (including connector loss)

Return Loss : > 45dB

FRM220-MD80 : 8 Wavelength CWDM Mux / DeMux Card

Wavelengths : 1470, 1490, 1510, 1530, 1550, 1570, 1590, 1610nm

Insertion Loss : < 2.8dB (including connector loss)

Return Loss : > 45dB

FRM220-MD80-1UP : 8 Wavelength CWDM Mux / DeMux Card + 1 upgrade port

Wavelengths : 1470, 1490, 1510, 1530, 1550, 1570, 1590, 1610nm

Upgrade port 1 : 1260 ~ 1457nm

Upgrade port isolation : > 30dB

Insertion Loss : < 2.8dB (including connector loss)

Return Loss : > 45dB

Environment :

Operating Temp.: 0°C – 50°C

Storage Temp. : -10°C – 70°C

Humidity : 5 – 90% (non-condensing)

Dimension : (D x W x H)

Single width blade : 155 x 88 x 23mm

Double width blade : 155 x 88 x 41mm

Weight :

Single width blade card : 200g

Double width blade card : 300g

Certification : RoHS

MTBF >275,000 hours

1.8.16 FRM220-iMUX Inverse Multiplexer Blades

The FRM220A-nE1/ET100 are 5, 8 or 16 E1 port inverse multiplexer cards with built-in Bridge for the FRM220/220A Series Platform Media Converter Rack. The multiplexers support bundling Unframed E1s using GFP-F (Generic Framing Procedure-Framed). The clock source may be selected internally or recovered from any one of the received E1 signals. The Ethernet port utilizes a single RJ-45 connector or SFP for optical fiber, depending on model. One single model supports either unbalanced 75 ohm or balanced 120 ohm (adapter cables required). When the FRM220A-nE1/ET100 card is placed in the FRM220A rack with GSW/SNMP management, the management can view the converter card's status, type, version, Ethernet link status and alarms. The card can be configured to enable or disable the port, reset the card, set clocking, Ethernet mode and provide E1 analog diagnostic loopbacks. A unique feature of the FRM220A-nE1/ET100 is the use of a common card design which may either be inserted in an appropriate single or dual slot chassis as a stand-alone modem or as a card when placed in the FRM220A-CH20 In-band managed rack.

Features

- Standalone type Ethernet to 5, 8, or 16 port E1 converter.
- Uplinks 100M Ethernet to aggregate trunk card of FRM220A
- Interface connectors, RJ-48C for 120Ω , BNCx2 for 75Ω per channel.
- E1s are bundled according to standard GFP-F
- LCAS (Link Capacity Adjustment Scheme) supports dynamic bandwidth of virtual concatenated containers.
- E1 settings.
 - E1 loopback (per channel)
 - 75 or 120 ohm impedance
- Timing source setting (Any receive E1 recovery or internal oscillator).
- Embedded Operations Channel (EOC) for remote in-band management.
- Integrated BERT function
- RMON counter for LAN Tx/Rx byte count.
- VLAN tag support
- Bandwidth control (32K to 100M)
- LED indicators



Specifications

▪ G.703 Interface

- **Connector** HDB26 Female with adapters for 75 or 120 Ohm
- **Data rate** 2048kb/s
- **Impedance** 75 ohm for unbalanced, 120 ohm for balanced
- **Framing** Requires Unframed, transparent clear channel E1s
- **RxSensitivity** -43dB (extra Long Haul)
- **TxPulseAmp.** 3.00V p-p (120 ohm); 2.73V p-p (75 ohm)
- **Line code** HDB3
- **Indications** LED (PWR, Alarm, Individual E1 status, Link, SD)
- **Ethernet Port** 1 x RJ-45, Auto-Negotiation, Auto-MDIX (T-model)
1 x caged SFP (100Base-FX) (S-model)
- **VLAN** IEEE802.1Q tagged VLAN support
- **Maximum MTU** 1916 bytes
- **Ingress/Egress** Bandwidth control (32K to 100M, nx32K granularity)
- **GFP-F** per ITU-T G.7041
- **LCAS** Enabled or disabled
- **Power** (Card supports hot-swapping)
- **Input** Card : 12VDC, Standalone : AC, DC options
- **Consumption** <6W
- **Dimensions** 155 x 88 x 23mm (D x W x H)
- **Weight** 120g
- **Temperature** 0 ~ 50°C (Operating), -10 ~ 70°C (Storage)
- **Humidity** 10 ~ 90% non-condensing
- **Certification** CE, FCC, LVD, RoHS
- **MTBF** 65000 hrs (25°C)
- **Test Loops** (set from console)
 - **E1** Remote and Request Remote Loop back
 - **BERT** Integral 511 pattern generator (set from console)



This product includes the following models:

FRM220A-5, 8, 16E1-ET100T (5E1, 8E1 or 16E1 with RJ-45 LAN)
 FRM220A-5, 8, 16E1-ET100S (5E1, 8E1 or 16E1 with SFP LAN)

1.8.17 FRM220-Eoe1 Ethernet over E1 Converter

The FRM220A-Eoe1 is a single port G.703/704 Fractional E1 DSU/CSU card with built-in HDLC Bridge for the FRM220/220A Series Platform Media Converter Rack. The converter supports Unframed, PCM31, and PCM30 framing modes. The clock source may be selected internally or recovered from received E1 signal. The Ethernet port utilizes a single RJ-45 connector. One single model supports either unbalanced 75 ohm with two BNC connectors or balanced 120 ohm with one RJ-45 connector. When the FRM220A-Eoe1 card is placed in the FRM220 rack with SNMP management, the management can view the converter card's status, type, version, Ethernet link status and alarms. The card can be configured to enable or disable the port, reset the card, set clocking, frame mode and provide analog diagnostic loopbacks. A unique feature of the FRM220A-Eoe1 is the use of a common card design which may either be inserted in the FRM220-CH01M single slot chassis as a stand-alone modem or as a card when placed in the FRM220-CH20 In-band managed rack.

Features

- Standalone type, 1 port E1 to HDLC converter.
- Uplinks 100M Ethernet to Gigabit trunk card of FRM220A
- Interface connectors, RJ-48C for 120? , BNC*2 for 75?.
- E1 settings.
- Line Code HDB3 or AMI.
- Full or Fractional.
- Frame setting, E1(CCS/CAS).
- Idle code setting (0x7E or 0xFF).
- Auto generate (AIS) enable, disable setting.
- Timing source setting (Receive E1 recovery or internal oscillator).
- Active timeslot number setting (E1 CCS 1-31 or E1 CAS 1-30).
- Base timeslot setting (E1 CCS 1-31, E1 CAS 1-15 or 17-31.)
- Loop Back with integral BERT
- LED indicators



Specifications

- G.703 Interface
 - Connector 1 x RJ-45 and 2 x BNC
 - Data rate 2048kb/s
 - Impedance 75 ohm for unbalanced, 120 ohm for balanced
 - Framing CCS, CAS, Unframed
 - RxSensitivity -43dB (extra Long Haul)
 - TxPulseAmp. 3.00V p-p (120 ohm); 2.73V p-p (75 ohm)
 - Line code HDB3 or AMI selectable
 - Indications LED (PWR, TD/RD act., Test, Signal loss, Sync loss, Alarm, Error)
- Ethernet Port 1 x RJ-45, Auto-Negotiation, Auto-MDIX
- Power (Card supports hot-swapping)
 - Input Card : 12VDC, Standalone : AC, DC options
 - Consumption <6W
- Dimensions 155 x 88 x 23mm (D x W x H)
- Weight 120g
- Temperature 0 ~ 50°C (Operating), -10 ~ 70°C (Storage)
- Humidity 10 ~ 90% non-condensing
- Certification CE (EMI/LVD), FCC, RoHS
- MTBF 75000 hrs (25°C)
- Tests (set from console)
 - E1 Loops Remote and Request Remote Loop back
 - BERT Integral 511 pattern generator (set from console)

This product includes the following models:

FRM220A-Eoe1 (Ethernet over E1 converter card)

1.8.18 FRM220-E1/Data DSU/CSU Converter Card

The FRM220-E1/Data is a single port G.703/704 Fractional E1 DSU/CSU card for the FRM220/220A Series Platform Media Converter Rack. The converter supports Unframed, PCM31, PCM31+CRC4, PCM30, and PCM30+CRC4 framing modes. The clock source may be selected internally, recovered from received E1 signal, externally from the Data port or transparent. The Data port interface utilizes a single Hi-Density 26pin connector. Cable solutions are provided for RS-530/449, X.21, V.35 and RS-232. The unit can recognize the cable type attached and automatically self-configure the interface circuits. Choosing from one of two model types, the E1 connection is either unbalanced 75 ohm with two BNC connectors or balanced 120 ohm with one RJ-45 connector. When the FRM220-E1/Data card is placed in the FRM220 rack with SNMP management, the management can view the converter card's status, type, version, E1 link status and alarms. The card can be configured to enable or disable the card, reset the card, set clocking, frame mode, interface type and provide analog or digital diagnostic loopbacks. A unique feature of the FRM220-E1/Data is the use of a common card design which may either be inserted in the FRM220-CH01 single slot chassis as a stand-alone modem or as a card when placed in the FRM220-CH20 In-band managed rack.

Features

- Standalone type, 1 port E1 to Synchronous Data converter.
- Interface connectors, RJ-48C for E1/Data-R, BNCx2 for E1/Data-B.
- E1 settings.
- Line Code HDB3 or AMI.
- Full or Fractional.
- Frame setting, E1(CCS/CAS).
- CRC enable/disable.
- Idle code setting (0x7E or 0xFF).
- Auto generate (AIS) enable, disable setting.
- Timing source setting (Receive E1 recovery, Internal oscillator, External from Synchronous Data port or transparent).
- Active timeslot number setting (E1 CCS 1-31 or E1 CAS 1-30).
- Base timeslot setting (E1 CCS 1-31, E1 CAS 1-15 or 17-31.)
- Loop Back with integral BERT
- LED indicators



Specifications

G.703 Interface

Connector	1xRJ-45 or 2xBNC (depending on model)
Data rate	2048kb/s
Impedance	75 ohm for unbalanced, 120 ohm for balanced
Framing	CCS, CAS, w or w/o CRC4, Unframed
RxSensitivity	-43dB (extra Long Haul)
TxPulseAmp.	3.00V p-p (120 ohm); 2.73V p-p (75 ohm)
Line code	HDB3 or AMI selectable

Indications LED (PWR, TD/RD act., Test, Signal loss, Sync loss, Alarm, Error)

Data Port HD26 w/cable for V.35, RS530, RS449, X.21 or RS232 (software selectable); DCE type

Power (Card supports hot-swapping)

Input	Card : 12VDC, Standalone : AC, DC options
Consumption	<6W

Dimensions 155 x 88 x 23mm (D x W x H)

Weight 120g

Temperature 0 ~ 50°C (Operating), -10 ~ 70°C (Storage)

Humidity 10 ~ 90% non-condensing

Certification CE, FCC, LVD, RoHS

MTBF 65000 hrs (25°C)

Test Loops (set from console)

E1 Local, Remote and Request Remote Loop back

Data Local, Remote and Request Remote Loop back

BERT Integral 511 pattern generator (set from console)



This product includes the following models:

FRM220-E1/Data-R E1 DSU/CSU Converter Card with RJ-45

FRM220-E1/Data-B E1 DSU/CSU Converter Card with BNC

1.8.19 FRM220-FTEC E1/T1 Cross Rate Converter Card

The FRM220-FTEC is a T1 (US Standard) /E1 (European Standard) converter and timeslot cross connect which enables conversion between one T1 signal and one E1 signal.

T1 and E1 signals with framing employ u-Law and A-Law compander encoding principles respectively and encode those analog (voice) signals into 64kbps digital data.

The T1 interface supports D4(SF) or ESF frame formats with B8ZS or AMI line code. The E1 interface supports CCS (PCM31) or CAS (PCM30) framing without CRC-4 and framing with CRC-4. The line coding is HDB3.

Tests and diagnostics can easily be performed from the local console interface or via Web based management of the FRM220. Diagnostics include T1 local/remote and E1 local/remote loop back.

Features

- Converts between T1 and E1 data and signaling
- Enable equipment to operate at T1 and E1 rates
- Support G.802 Annex B (T1 over E1)
- Configures A-law/u-law and signaling conversion
- Transparent conversion at 64kbps timeslot level
- Controlled slip for buffer over or under flow
- 24 timeslots of T1 Nx64 can be inserted into E1 Nx64, 30/CAS or 31/CCS timeslots

Specifications

T1 Interface Specifications

- Complies with: ITU-T G.703 Recommendation
- Bit rate: 1.544Mbps
- Frame format: D4(SF) or ESF selectable
- Line code: AMI or B8ZS selectable
- Equalization: 0-655 feet settable
- Voice channel sample rule: u-Law
- CRC check: CRC-6 (when ESF)
- Impedance: 100 Ohm balanced
- Transmit pulse level: +/-3.0V (10%)
- Receive signal level: 0 to -36dB
- RJ-45 Connector USOC RJ-48C

E1 Interface Specifications

- Complies with: ITU-T G.703 Recommendation
- Bit rate: 2.048Mbps
- Frame format: CAS (PCM30) or CCS (PCM31)
- Line code: HDB3
- Voice channel sample rule: A-Law
- CRC check: CRC-4 enable/disable
- Impedance: 75 Ohm or 120 Ohm selectable
- Transmit pulse level: 75 Ohm +/-2.37V (10%)
- Impedance: 120 Ohm +/-3.0V (10%)
- Receive signal level: 0 to -30dB
- RJ-45 Connector USOC RJ-48C
- BNC via RJ-45 to 2xBNC adapter cable

Timeslot mapping selectable

- E1 CAS mode: TS1-TS15, TS17-TS31 any 24 timeslots
- E1 CCS mode: TS1-TS31 any 24 timeslots

This product includes the following models:

FRM220-FTEC E1/T1 Cross Rate Converter Card



1.8.20 FRM220-1000TS GbE to Gigabit Fiber Converter Card

The FRM220-1000T(S) is a 1000Base copper to fiber converter which transparently supports any protocol or packet size. This slide-in fiber media converter is available in two different models that work stand-alone or as line cards for placement in the FRM220 Platform Media Converter chassis. The FRM220-1000T uses a fixed optical transceiver while the FRM220-1000TS features an standard SFP socket. The FRM220-CH01 is a stand-alone case for FRM220 slide-in cards with built-in power supply features.

All media converters are available with either multi-mode or single-mode optical transceivers with SC connectors for fixed transceivers or LC connectors for the SFP version. In single mode, WDM (Wave Division Multiplexing with SC or LC) or "Bidi" are also available in 20, 40, 60km reach, which provide the ability to transmit and receive data using only a single optical fiber. When the FRM220-1000T(S) card is placed in the FRM220 rack with SNMP management, the card status, type, fiber link status and UTP link status can all be displayed.

This converter is excellent when used in high speed gigabit networks that employ jumbo packets. The FRM220-1000T(S) supports unlimited packet size and has extremely low latency.

Features

- 1000Base-T to 1000Base-SX/LX
- Network management via terminal, web or SNMP in FRM220 chassis
- Forced 1000Base/Full Ethernet
- Auto MDI/MDIX
- Pass > 9K bytes packets
- Supports Link Fault Pass Through (LFP) function
- Auto Laser Shutdown (ALS)

Specifications

Standards

- IEEE802.3ab 1000Base-T, IEEE802.3z 1000Base-SX/LX, Gigabit Standards

1000Base-T RJ-45 Connectors

- 1000T(S) : One RJ45 connector is provided for UTP cable connection

All RJ45 ports utilizing auto MDI/MDIX, which allow all UTP connections for both straight and crossover UTP cable.

1000Base-X Fiber Optic Connectors

- 1000TS : One SFP slot is provided for standard 1.25Gbps SFP module.

Environment

- Operating -10 to 60C
- Storage -20 to 70C
- Humidity -- 10 to 90%, (non-condensing)

Power

- Adapter: 12V DC 1A (CH01-DC12)
- Built-in AC Power 100~240 V (CH01-AC)
- Built-in DC Power 18~72VDC (CD01-DC)

Dimensions: (W x D x H) mm

- 1000TS-DC12 : 88 × 160 × 24 1000T(S)-AC: 135 × 201 × 35
- 1000TS-DC48 : 135 × 201 × 35 1000T(S)-AD/AA/DD: 135 × 201 × 35

This product includes the following models:

FRM220-1000TS GbE to Gigabit Fiber Converter Card

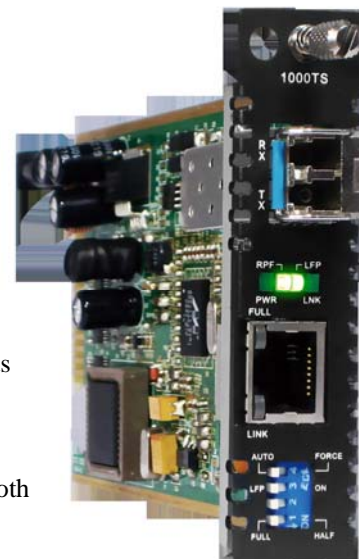

1.8.21 FRM220-4G 2R 4.25G Transponder Card

FRM220-4G-2S is a multi-rate, 28M to 4.25G 2R optical repeater device. The "2R" consists of Re-amplification and Re-shaping. The transponder card converts a data signal to the correct wavelength for transmission on a specific channel by supporting SFP optics on both line side and client side interfaces. When FRM220-4G-2S card is placed in FRM220 rack with SNMP management, the management can view the converter card's status, type, version, fiber link status and alarms. The card can be configured to enable or disable the port, reset the port, provide client or line side diagnostic loop back, and set the desired data rate.

FRM220-4G-3S is in every way the same as the 2S model except an additional optical port is added to provide 1+1 optical protection. Automatic optical line Protection Switching is supported for the aggregate fiber port.

Features

- Supports multiple protocols and data rates from 28Mbps to 4.25Gbps.
- 2R Repeater functions for re-amplification and re-shaping.
- Low cost transponder application.
- Available with redundant fiber support (3S model).
- Supports rack management or stand-alone.
- Supports Auto-Laser Shutdown (ALS) and Link Fault Pass through (LFP).
- Supports both line side and client side optical loop backs.
- Digital Diagnostic Monitor of supported SFP modules.
- Optical Connector: SFP-LC (On both Line & Client Side)

Specifications

Optical Interface :	Connector :	SFP LC
	Data rate :	28Mbps ~ 4.25Gbps
	Fiber :	MM 62.2/125 μ m, 50/125 μ m. SM 9/125 μ m
	Distance :	2~120km
	Wavelength :	850, 1311, 1471 ~ 1611nm
Indications	Power, Link(Line), Link(Client), TX/Act, Loopback	
Power Input	Card: 12 VDC Stand-alone: AC, DC option	
Power Consumption	<5W	
Dimensions	155 x 88 x 23mm(D x W x H)	
Weight	120g	
Temperature	0~60°C (Operating), -10~70°C (Storage)	
Humidity	10~90% non-condensing	
Certification	CE, FCC, RoHS	
MTBF	75,000 hours	



This product includes the following models:

- FRM220-4G-2S 2R 4.25G Transponder Card
- FRM220-4G-3S 2R 4.25G Transponder Card w/1+1 fiber protection

1.8.22 FRM220-Serial/FDC RS-485/RS-232 Fiber Ring Converter Card

The FRM220-Serial/FDC provides a dual fiber connection converter solution to extend asynchronous RS-485 or RS-232 transmission distance up to 2km over multimode fiber or up to 120km over single mode fiber. The dual fiber inputs allow connecting multiple devices in a cascade or "daisy chain" fashion as well as creating ring architecture for fiber redundancy. The converter is equipped with multiple interface circuits for connection to RS-232 or RS-485/422 (2 or 4 wire, full or half duplex). The FRM220-Serial/FDC secures data transmission over EMI resistant fiber at speeds up to 256kbps for RS-232 or up to 1024kbps for RS-485/422. When the FRM220-Serial/FDC card is placed in the FRM220 rack with SNMP management, in-band management allows viewing the card and remote converter's status, type, version, fiber link status, data link status and alarms. Both card and remote can be configured to enable or disable the port and set the interface type.

Features

- Extend asynchronous serial transmission from 2km to 120km over fiber
- In-band management via terminal, GUI or SNMP in FRM220 chassis
- Two fiber ports support daisy chain and ring architecture
- Multi-drop operation over fiber ring
- Software selectable data interface for RS232/ 422/ 485
- Software selectable two wires (half duplex) or four wires (full duplex) RS485
- Software selectable three or five wires RS232
- Speeds up to 256kbps for RS232 (Async. mode)
- Speeds up to 1Mbps for RS485/422

Specifications

Ports

Optical Interface

Connector : 2x SFP LC
 Data rate : 36.864Mbps
 Line coding: Scrambled NRZ
 Bit Error Rate: Less than 10^{-10}
 Cable type : MM 62.2/125 μ m, 50/125 μ m. SM 9/125 μ m
 Distance : MM 2km, SM 15/30/50/80/120km, WDM 20/40/60/80km
 Wavelength: 1310nm, 1550nm,

Electrical Interface

Connector : 6 pins Terminal block
 Data Signal Formats
 RS485 2-wire
 RS422 4-wire
 RS232 RTS/CTS 5-wire
 RS232 3-wire
 Baud Rate:
 RS422, RS485 up to 1024kbps
 RS232 up to 256kbps

Standard

EIA/TIA RS485, RS422, RS232

LEDs

Power, FX Link, DI, DO, Test

Power

DC In 12V

Power Consumption

< 5W

Dimension (D x W x H) mm

155 x 88 x 23mm

Weight

120g

Temperature

-10~60° C (Operating) , -20~70° C (Storage)

Humidity

10~95% non-condensing

Certification

CE LVD/EMI, FCC, RoHS

MTBF

65,000 h (25° C)

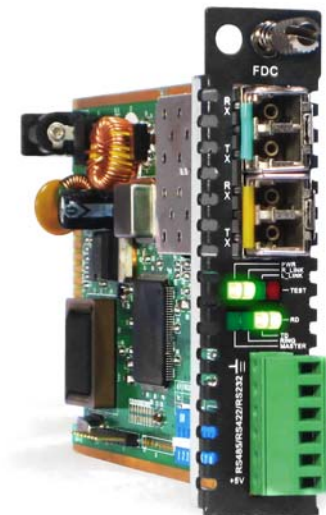

This product includes the following models:

FRM220-Serial/FDC RS485/232 Fiber Ring Media Converter Card

1.8.23 FRM220-FOM04 4xE1/T1 +100M Ethernet Fiber Optical Multiplexer Card

FRM220-FOM04 is a modular design for 4xE1/T1 + Fast Ethernet multi-service to dual strand fiber PDH multiplexer. FRM220-FOM04 provides E1/T1 transmission transparently and pure 100Mbps Fast Ethernet simultaneously. The fiber optic line is based on the SFP technology that allows the flexible use of Multimode or Single mode lines and enables the support of different wavelengths and distances. The use of bi-directional SFPs maximizes the utilization of the fiber optic line and results in saving line costs. With SNMP and Web-based management in the FRM220, the Network administrator can monitor, configure and control the activity of each card in the chassis.

Features

- 4 channels unframed E1/T1
- 10/100Base-TX Ethernet
- Auto MDI/MDIX
- Auto-Negotiation or Force mode
- Supports flow control
- Supports 9K jumbo packets
- Supports Link fault pass through (LFP)
- One clear channel RS232 up to 250Kbps(Async)
- 1+1 fiber protection, less than 50ms
- Supports Digital Diagnostics Monitoring Interface (DDMI)
- AIS on signal loss on E1/T1 and fiber port
- Loopback test on Optical, E1/T1, and RS232 ports
- Supports Dying Gasp
- Two row by twelve character LCD/Menu Keys for configuration
- Supports local or remote In-band management
- Monitor and Configuration status by console port and SNMP manager
- Supports Order wire Ear / Microphone port
- Supports On-Line F/W upgrade



Specifications

E1/T1 ports

Framing	Unframed (transparent)
Bit Rate	E1: 2.048 Mb/s, T1: 1.544 Mb/s
Line Code	E1: AMI/HDB3, T1: AMI/B8ZS
Line Impedance	E1: Unbalanced 75 ohms (BNC cable) E1: Balanced 120 ohms (RJ-45) T1: Balanced 100 ohms (RJ-45)
Receiver sensitivity	Short haul
"Pulse" Amplitude	Nominal 2.37V +/- 10% for 75 ohms Nominal 3.00V +/- 10% for 120 ohms
"Zero" Amplitude	Nominal +/- 0.3V
Transmit Frequency Tracking	+/- 30 ppm
Internal Timing	Crystal Oscillator
Jitter Performance	According to ITU-T G.823
Performance monitoring	According to ITU-T G.821
Standards	ITU-T G.703, G.704, G.706 and G.732
Interface Connectors	RJ-45, BNC
Test Loops	LLB (Local Loop Back) RLB (Remote Loop Back)

Ethernet

Interface Type	10/100Base-TX
Connector	RJ-45
Standards	IEEE 802.3, 802.3u
Duplex modes	Full/Half

Indications OP1 Link, OP2 link, E1/T1 Mode/Link/Loopback test, Order wire, LAN Link/Speed.

Power Input AC adapter, 12VDC (or with built-in power in CH20 or CH02M)

Dimensions 88 x 42 x 139mm(DxWxH)

Temperature 0 ~ 60°C (Operating), -10 ~ 70°C (Storage)

Humidity 10 ~ 90% RH (non-condensing)

Certifications CE, FCC, RoHS

This product includes the following models:

FRM220-FOM04 (Fiber Multiplexer Card)

FOM220-FOM04-CH02M (Stand-alone FOM in 2-slot chassis)

Chapter 2 Installation

2.1 Introduction

The Installation chapter will cover the physical installation of the **FRM220-CH08**, Rack Mount In-Band Managed Series Fiber Converter Platform Chassis, the electrical connections, interface connections and cabling requirements. A brief overview of the functional components such as main unit and management options will also be outlined in this chapter.

Required Tools

You will need these tools to install the **FRM220-CH08**:

Number 2 Phillips screwdriver for the 3mm and the 12-24 rack installation screws.

Wrist strap or other personal grounding device to prevent ESD occurrences.

Antistatic mat or antistatic foam to set the equipment on.

2.2 Site Preparation

Install the **FRM220-CH08** within reach of an easily accessible grounded AC outlet or three wire (-48VDC, Power return, Earth Ground) central office power. The AC outlet should be capable of furnishing 100 to 240 VAC. Refer to 2.4 Electrical Installation. Allow at least 10cm (4 inch) clearance at the front of the **CH08** for the Fiber and other copper cables.

2.3 Mechanical Assembly

CH08 is designed for rack mount installation and will require 1U space in a standard EIA 19" or 23" rack. **CH08** chassis is delivered completely assembled, however power modules and converter cards may or may not be installed in the chassis upon delivery. The rack mount adapters may be placed along the front or centrally located on the chassis.

2.3.1 Rack mounting

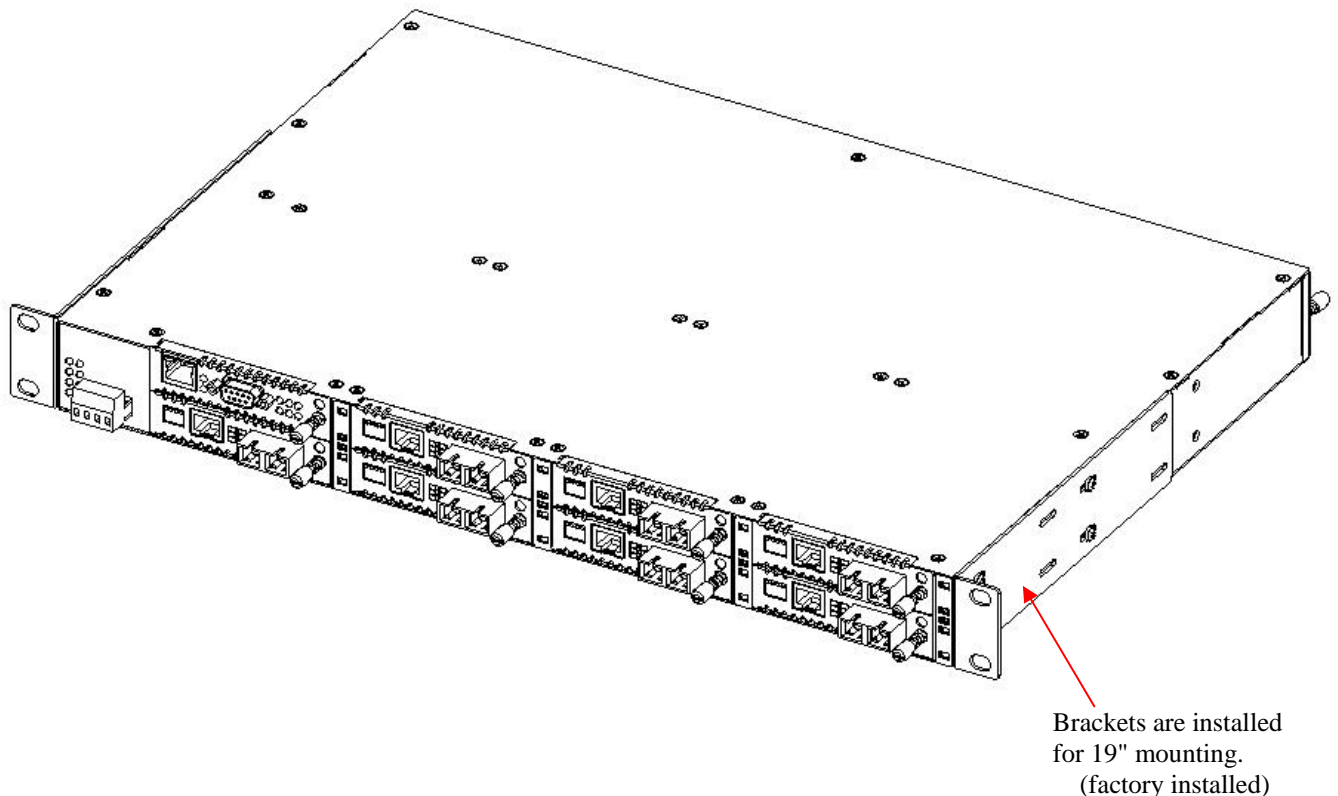

Figure 2-1 Standard 19" Rack-Mount Installation of **CH08** Unit requires 1RU space

2.3.2 Power/Fan Modules Removal/Replacement

The Power Supply Modules in **CH08** are available in three versions, one AC and two DC types. The universal AC version supports input voltages of 100 to 240 ($\pm 10\%$ @ ambient temperature) volts at frequencies of 47 to 63 Hertz. The DC versions support an input range of either 36 to 60VDC or 18 to 36VDC. Only one power supply module is required to power a completely full rack. When two Power Supply Modules are installed, the supplies are hot swappable and redundant, meaning any one supply may be removed and replaced without impacting the operation of **CH08** Rack. **If the chassis will be used to power 3R transponder cards such as the 2.7G and 10G, the chassis will require two power/fan modules or overheating could result.**

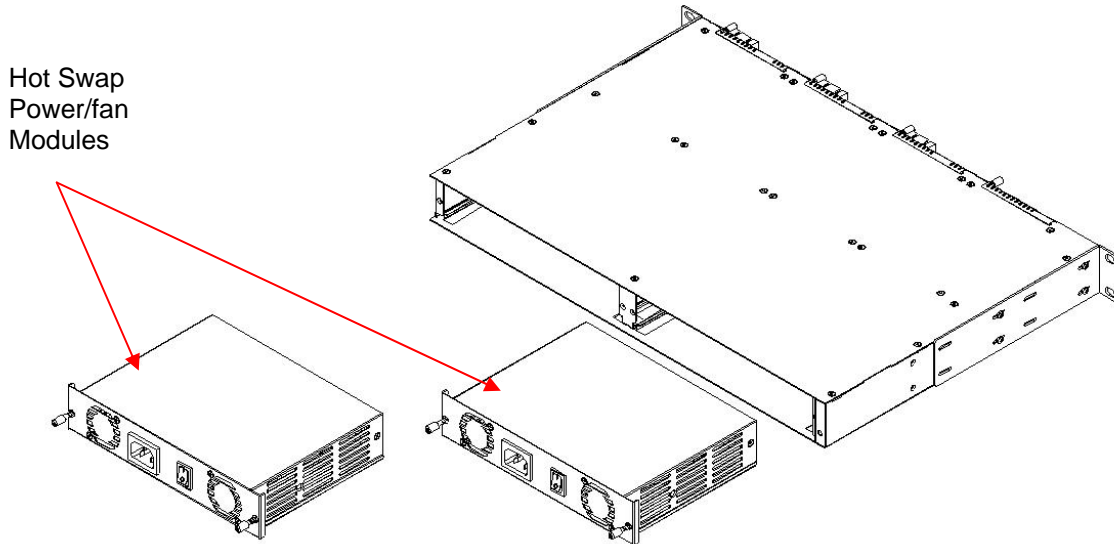

Figure 2-2 Power Modules for **CH08**

2.3.3 Line Card Conversion, Stand-alone/Rack

The **FRM220** Media Converter Line Card may be mounted in the **FRM220-CH08** or **CH20** chassis or serve as a stand-alone unit. When installing in the **FRM220-CH01** single slot chassis or **FRM220-CH02** dual slot chassis, the outer cover holds the line card. The unit then serves as a stand-alone media converter that can be linked to a line card in the **FRM220** chassis.

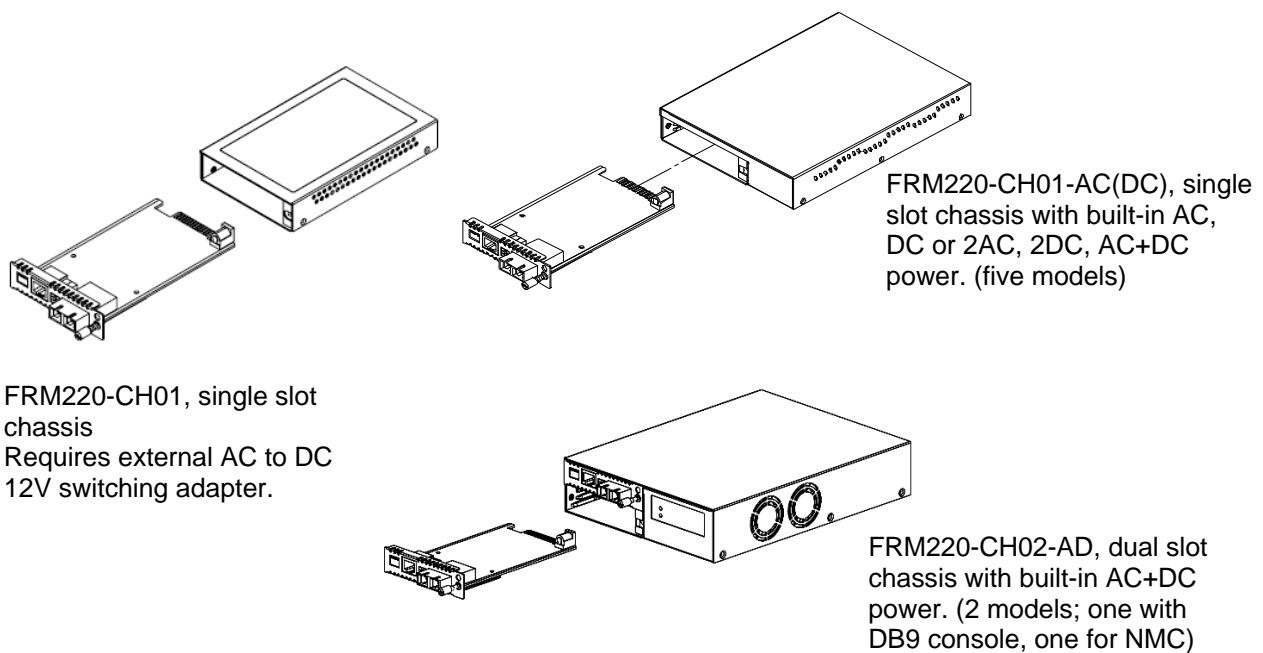

Figure 2-3 Converting **FRM220** line card for stand-alone use

2.4 Electrical Installation

With an AC power module, AC power is supplied to **CH08** through a standard IEC C14 3-prong receptacle, located on the rear of the module. Any national power cord with IEC C13 line plug may be used to connect AC power to the power module. With a DC24 or DC48 module, DC voltage is connected to the terminal block located on the rear of the module, observing the proper polarity. **CH08** should always be grounded through the protective earth lead of the power cable in AC installations, or via the frame ground connection for DC installations.

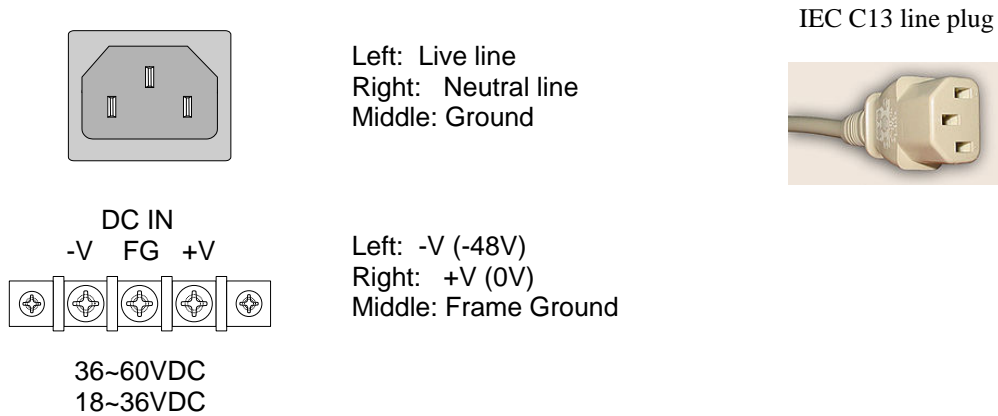

Figure 2-4 IEC (AC) & terminal block (DC) power connector pin assignment

2.5 Alarm Installation

The alarm relay provides one set of Power Failure contacts (normally open) and another set of FAN Failure contacts (normally open) contacts for monitoring the power and fans condition of **CH08**. The alarm contacts may also be programmed through the management interface to react to different fault conditions.

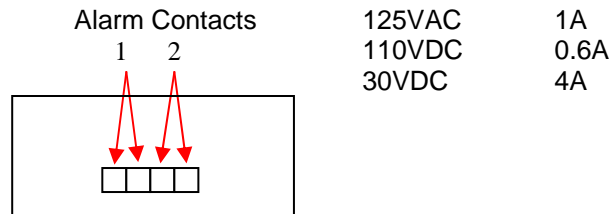

Figure 2-5 Alarm Relay Contacts

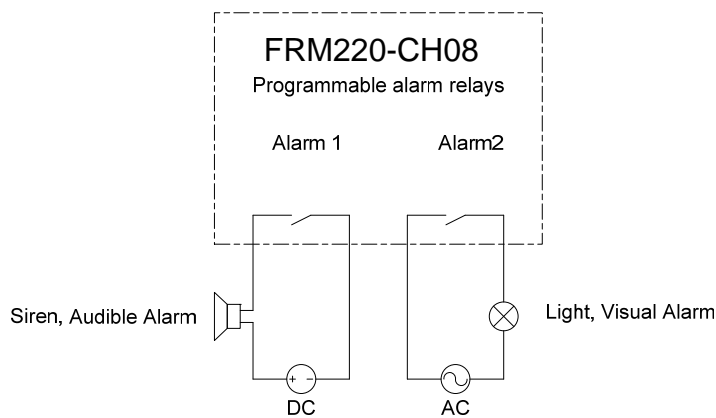

Figure 2-6 Example of electrical circuit for visual and audible alarms

2.6 NMC Card Installation

Slot number 1 of the chassis is reserved for the Network Management Controller (NMC). The NMC card provides the full network management features. When the NMC is installed, the rack and all line cards become manageable by industry standard SNMP protocol. (Please refer to Chapter 3 for more information on the operation of the network management features). The remaining slots, numbered 2 through 8, may contain any other FRM220 Series In-band Managed fiber media converter card.

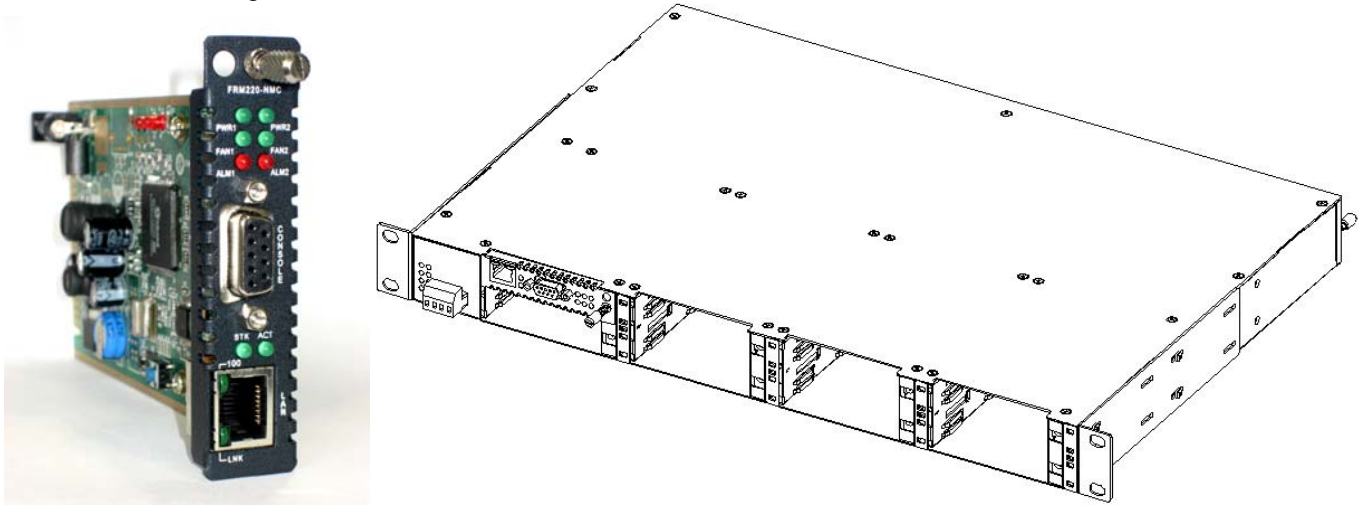

Figure 2-7 NMC removal/replacement in slot number 1

IMPORTANT: In the FRM220 In-Band Managed Rack, slot number 1 must contain an NMC card. In a chassis where non-managed line cards are employed (cards that use DIP switch settings), slot number 1 may then be used for a non-managed media converter line card.

2.7 Line Card Installation

The Line Cards for the **FRM220 Series** are Fiber Media Converter Cards which slide into **CH08** chassis, and interface with the back panel "main board". The back panel provides a connection to the converter cards for power and serial control.

The media converter cards are designed to be "hot" swappable, meaning **CH08** chassis need not be powered off in order to remove or replace a card. Removal and installation of converter cards with the rack chassis under power will not affect the operation of other converter cards.

Removal of a converter card is accomplished by loosening the one (1) captive screw (right) and then pulling the card straight out of the chassis with the same screw. Replace the card by reversing the procedure, align in the slot groove and gently seat the card, retightening the captive screw.

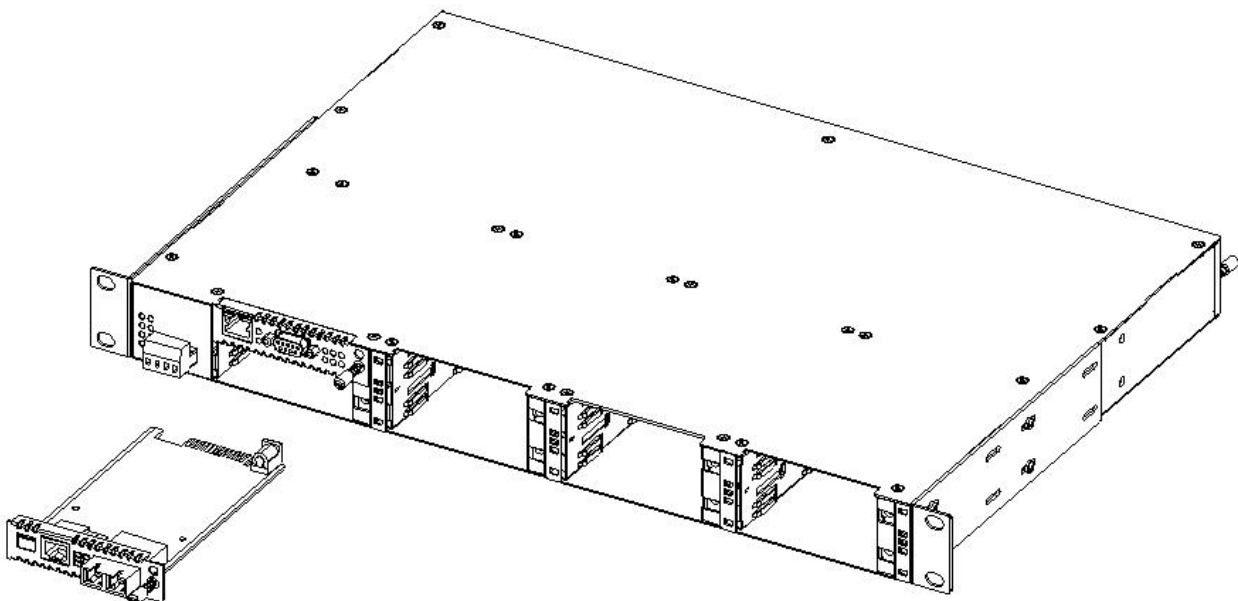

Figure 2-8 Line card removal/replacement

Chapter 3. Management Quick Start

3.1 Introduction

The information here is only a brief introduction to the management interfaces and methodologies for managing the FRM220. For in-depth use of the management features of the FRM220, please refer to the **FRM220 NMC User Manual**.

3.2 Management Methods

The management methods for the FRM220 include textual based serial console, IP based textual console (Telnet), web based GUI management through web browser, SNMP management through proprietary MIB and via CTC Union's Element Management System (EMS).

3.3 Console Terminal

The NMC card has a DB9F RS-232 serial console port for local management purposes. The console provides a menu driven display, with simple keyboard item selections and the ability to control all aspects of management in the FRM220. The console interface also provides the initial provisioning to setup the TCP/IP interface (the Ethernet RJ-45 10/100Base-TX port) for remote management by Telnet, Web, SNMP and EMS.

3.3.1 Terminal Connection & Settings

The DB9F port on the NMC is a DCE (Data Communications Equipment) wired device that allows for direct 1:1 cable connection to the DTE (Data Terminal Equipment) of PC's COM port. The FRM220 includes the 1:1 DB9F to DB9M serial cable for connection to PC's COM port or laptop's USB to RS-232 adapter. Any VT100 terminal emulation program for Windows may be used, including HyperTerminal™, TeraTerm, or PuTTY.

The terminal settings must follow these communication parameters:

115200 data rate
8 bits
No parity bit
1 Stop bit
No Flow Control

3.3.2 Terminal Login

Connect the console cable to PC and power up the FRM220. Start your favorite terminal emulation program. The terminal screen is refreshed every few seconds. By default, no password is set from the factory, so you should immediately see a screen similar to that below.

```

1  {
    *****
    *** CTC UNION TECHNOLOGIES CO., LTD. ***
    *** FRM220 NMC VER. 3.36 ***
    *****

2  {
    <1>: SLOT #01 > NMC & Chassis
    <2>: SLOT #02 > Empty
    <3>: SLOT #03 > FRM220-10/100I
    <4>: SLOT #04 > FRM220-10/100I
    <5>: SLOT #05 > FRM220-DATAPORT
    <6>: SLOT #06 > FRM220-E1/T1
    <7>: SLOT #07 > FRM220-SERIAL
    <8>: SLOT #08 > FRM220-SERIAL

3  {
    <L>: SNMP System Configuration Setup
    <M>: SNMP Manager Configuration Setup
    <P>: Password Setup
    <R>: Reboot <Z>: Logout
    Please select an item.
  
```

Items of interest:

1. This is the display header. The version shown reflects the currently installed 'romfs.gz' or file system version (3.36).
2. This block supports selecting any of the installed cards, numbered in slots 1~8.
3. In this block of commands is the all important 'SNMP System Configuration Setup'. The TCP/IP settings are done through this selected menu.

3.3.3 TCP/IP Setup

From the main menu, use the 'L' key to enter the 'SNMP System Configuration Setup' menu. An example menu is displayed below.

```

1  {
2  {
3  {
4  {
5  {
    *****
    *** CTC UNION TECHNOLOGIES CO., LTD. ***
    *** FRM220 NMC VER. 3.36 ***
    *****
    << SNMP System Configuration Setup >>
    Model = NMC
    S/N = 000000
    Target MAC Address = 00:02:ab:0d:79:ea
    <1>: Target IP : 192.168.0.250
    <2>: Target Netmask : 255.255.255.0
    <3>: Target Gateway : 192.168.0.10
    <4>: Target Name : NMC
    <5>: TFTP Server IP : 192.168.0.49
    <6>: TFTP Download Kernel : kernel16422.gz
    <7>: TFTP Download File System : romfs336.gz
    <8>: Load default settings and write to system.
    <9>: Do TFTP and Flash Kernel function.
    <A>: Do TFTP and Flash File System function.
    <T>: Adjust Date and Time.
    <U>: Upgrade Line Card Menu.
    <ESC>: Write to system and go to previous menu.
    Please select an item.
  
```

Items of interest:

1. This is the display header. The version shown reflects the currently installed 'romfs.gz' or file system version (3.36).
2. The model name and serial number are shown in this section.
3. The TCP/IP settings for IP, subnet mask, default gateway and hostname and set using keyin 1~4.
4. Items 5~A handle setting and upgrading via TFTP protocol. Set the TFTP server's IP and names of the kernel and filesystem file names. Execute upgrade as directed in the upgrade procedure included with each update package.
5. Item 'T' is used to setup the SNTP time protocol so that this management can synchronize time with a time server. Item 'U' enters the menu to upgrade line cards in the FRM220.

Setup the default gateway, subnet mask and IP address as instructed by your network administrator. After any TCP/IP setting change, the NMC must be rebooted. So, ESC back to the main menu and key-in 'R' to reboot and confirm with 'Y' (yes).

3.3.4 Test TCP/IP Connection

Open a command window and ping the FRM220. Make sure the network settings are correct.

```

C:\>ping 192.168.0.250

Pinging 192.168.0.250 with 32 bytes of data:
Reply from 192.168.0.250: bytes=32 time=2ms TTL=64
Reply from 192.168.0.250: bytes=32 time=1ms TTL=64
Reply from 192.168.0.250: bytes=32 time=1ms TTL=64
Reply from 192.168.0.250: bytes=32 time=1ms TTL=64

Ping statistics for 192.168.0.250:
    Packets: Sent = 4, Received = 4, Lost = 0 (0% loss),
    Approximate round trip times in milli-seconds:
        Minimum = 1ms, Maximum = 2ms, Average = 1ms

C:\>
  
```

3.4 Telnet Terminal

Use either a Windows® command window or Telnet client application and connect to the FRM220 NMC using the assigned management IP address. The following is an example of a Telnet screen. It is exactly the same as a local serial console screen, only it can be accessed remotely.

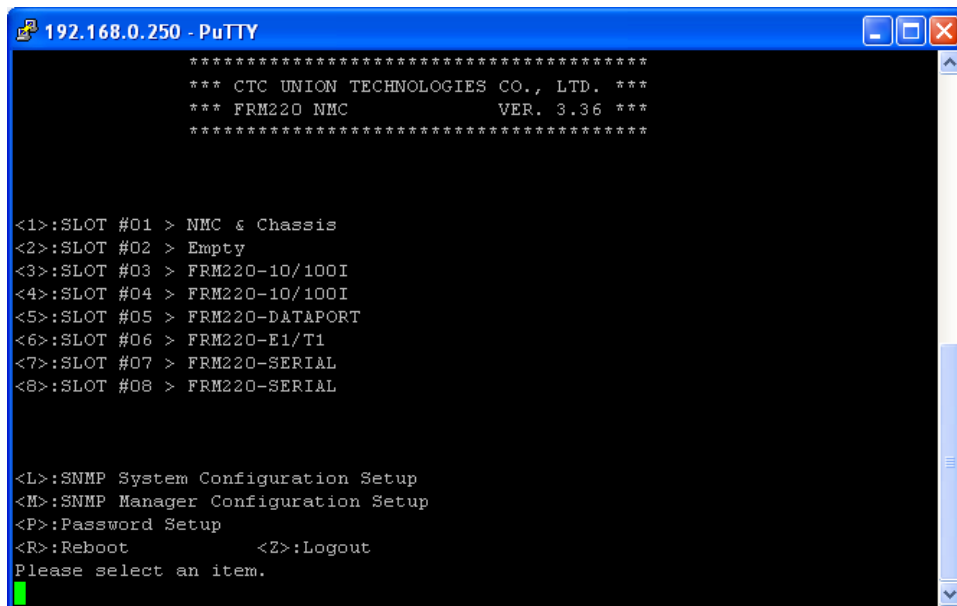

3.5 Web Based Manager

The FRM220 NMC supports web based management. Use your favorite browser (Internet Explorer or Firefox) and connect to the FRM220 NMC by using the NMC's IP address. Refer to the FRM220 NMC User Manual for details.

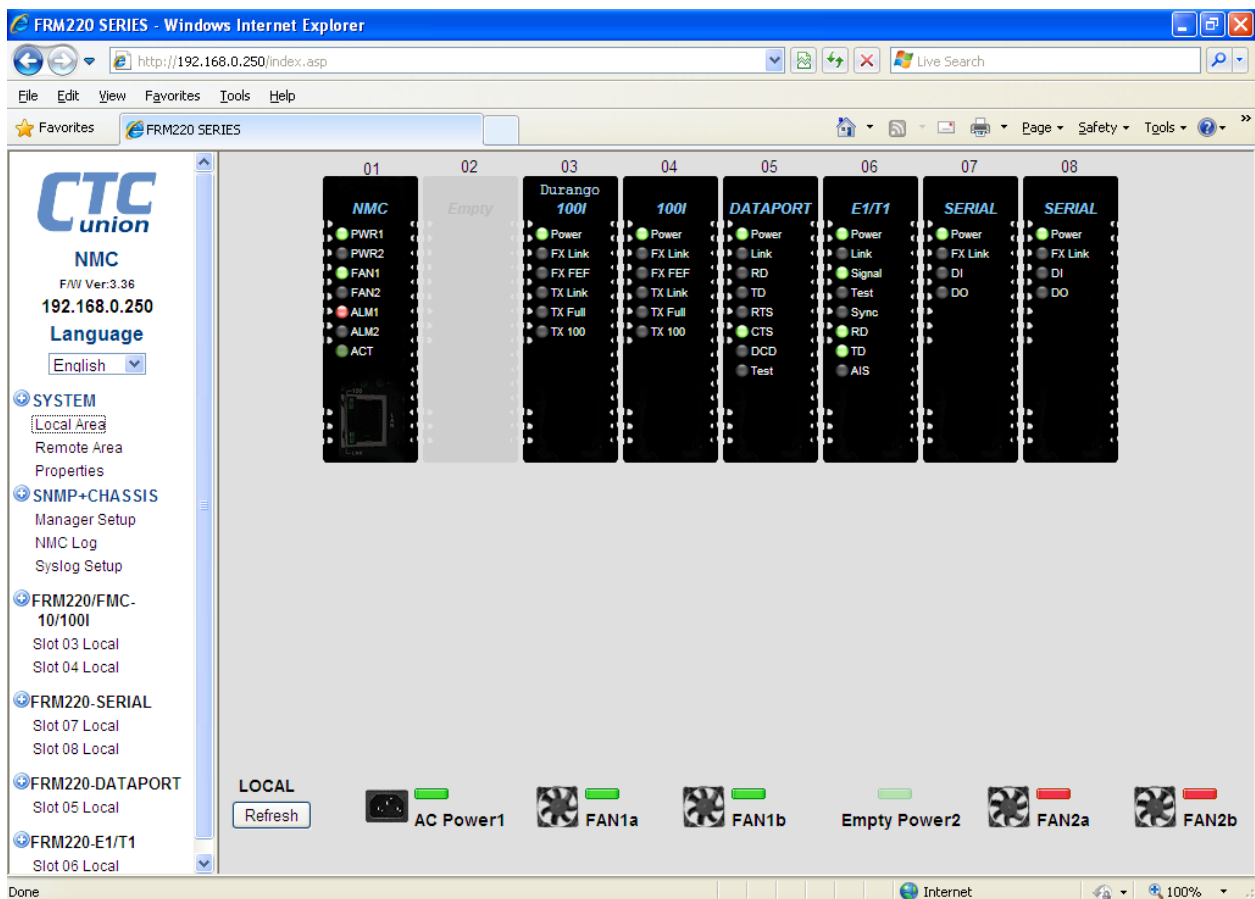

3.6 Element Management System (EMS)

The objective of an Element Management System is to provide four major functions for telecommunication operators:

- Fault Management (FM)
- Performance Management (PM)
- Configuration Management (CM)
- Security Management (SM)

CTC Union's EMS is a proprietary management system designed to provision, monitor and maintain multiple equipments designed by CTC Union. It is a client/server architecture using a Windows® based server with Microsoft MS-SQL Server for a database and Java based server and client. The client software can be run on the server or remotely on another physical machine as long as there is an IP connection between the client and server. Refer to the EMS User Manual for details.

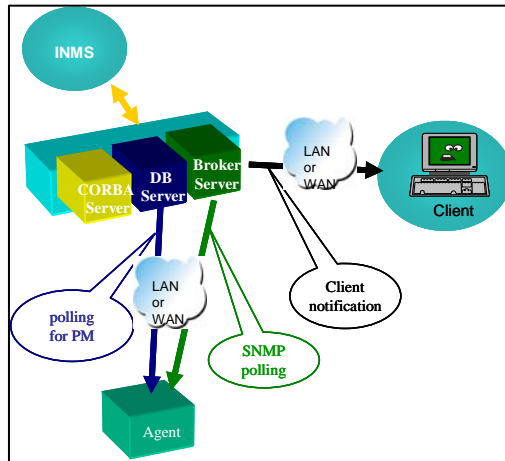

The EMS administrator creates users with different permissions and builds different management trees. Public trees can be seen by all users while private trees can only be seen by their creator. Client interface provides provisioning functions and the viewing and handling of Alarms, Traps and performance data.

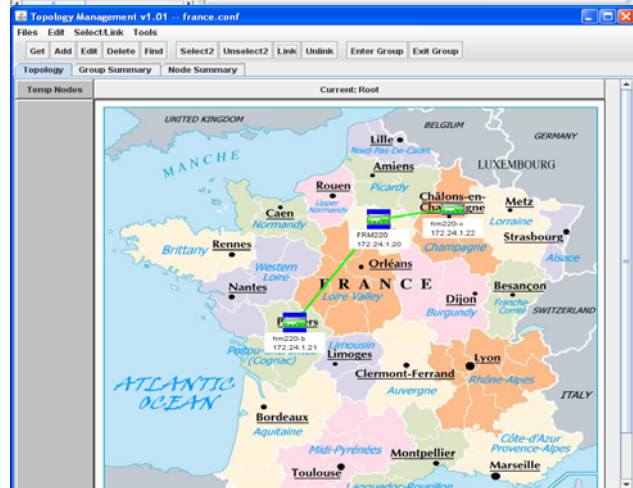
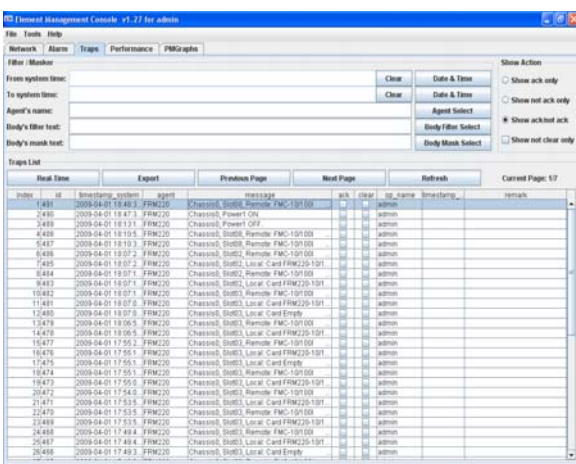
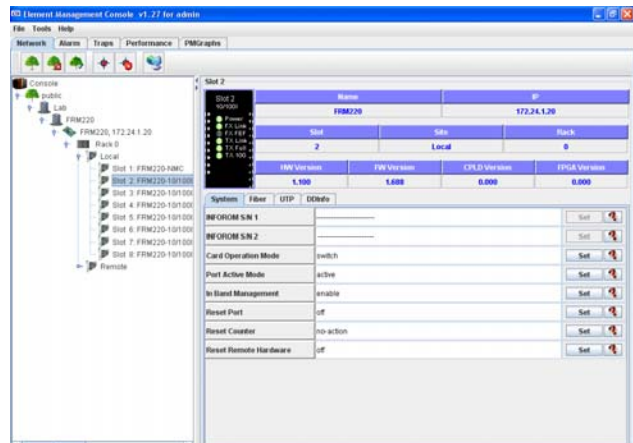
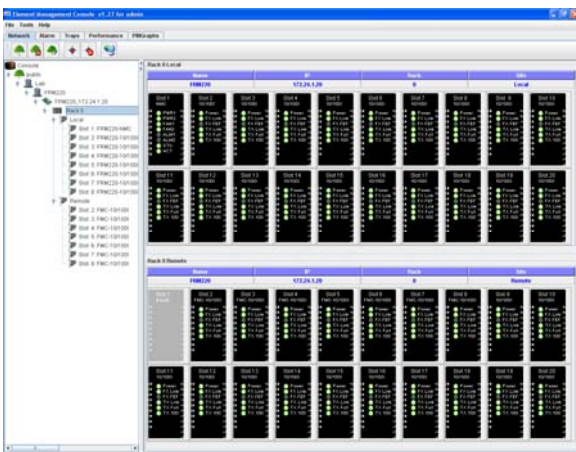



www.ctcu.com

T +886-2 2659-1021 **F** +886-2 2659-0237 **E** info@ctcu.com



ISO 9001 Quality System Certified CTC Union Technologies Co.,LTD.

All trademarks are the property of their respective owners. Technical information in this document is subject to change without notice.