



# SNMP-EMPV2

Environmental Monitoring Sensor

User & Installation Manual

**Table of Contents**

**Introduction.....3**

**Features.....3**

**Specifications.....4**

**Applications.....4**

    Connect to SNMP-3PEX.....4

**Settings.....5**

    How to Set RFID.....5

    How to Set Wireless Smoke/Gas Sensor.....6

    How to Set Wireless Door/Window Sensor.....7

    How to Set Wireless Glass-break Sensor.....8

    How to Set InfraRed Beam Detector.....9

    How to Set PIR Sensor.....10

## Introduction



**SNMP-EMPV2**

SNMP-EMPV2 can detect variation in temperature, humidity and presence of water. It can also be used with the following add-on devices:

1. Wireless Smoke sensor
2. Wireless Gas sensor
3. Wireless Door/Window sensor
4. Wireless Glass-Break sensor
5. Wireless InfraRed Beam detector
6. Wireless PIR sensor

When an event occurs, SNMP-EMPV2 alarm will buzz. It can also be configured to simultaneously send an email thru SNMP-3PEX. When connected to SNMP-2PV2, it can then provide environment status feedback (temperature, humidity and water presence) via the internet using a standard browser.

## Features

1. Able to measure variations in temperature, humidity and presence of water.
2. Built-in radio frequency ("RF") receiver.
3. Support up to 7 individually ID'd wireless Door / Window sensor to detect unauthorized access.
4. Support Wireless Smoke or Gas sensor to trigger alarm and send notification. Only one ID is available per type. More than one unit can share the same ID.
5. Support Glass sensor.
6. Support InfraRed Beam detector.
7. Support Passive InfraRed ("PIR") for motion detection.

## Specifications

Humidity Specification	
Detection Range	0 to 100% Relative Humidity non-condensing
Accuracy	±3.0% Relative Humidity
Response Time	10 Sec.
Temperature Range	-40°C to +75°C (-40°C to +75°C)

Temperature Specification	
Detection Range	-40°C to +70°C
Accuracy	±3°C
Response Time	10 Sec.

RF Specification	
Detection Range	6~10 meter visible range
Frequency	315MHZ
Sensitivity	-105dB

## Applications

### Connect to SNMP-2PV2

1. Monitor environment data via a standard web browser
2. Send Email when an event occurs
3. Powered either directly from SNMP-2PV2
- 4.

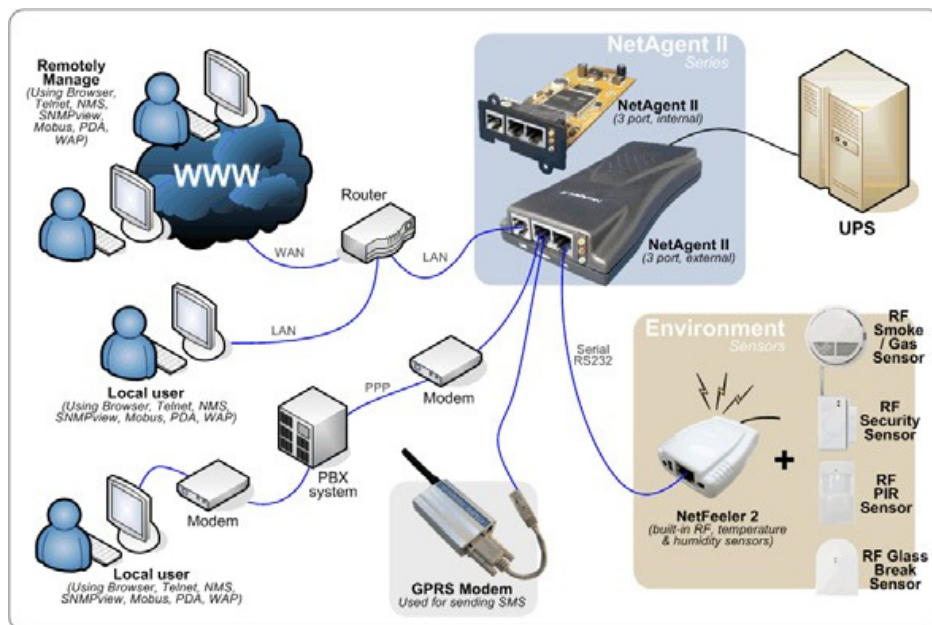

Connect to SNMP-2PV2

## Settings

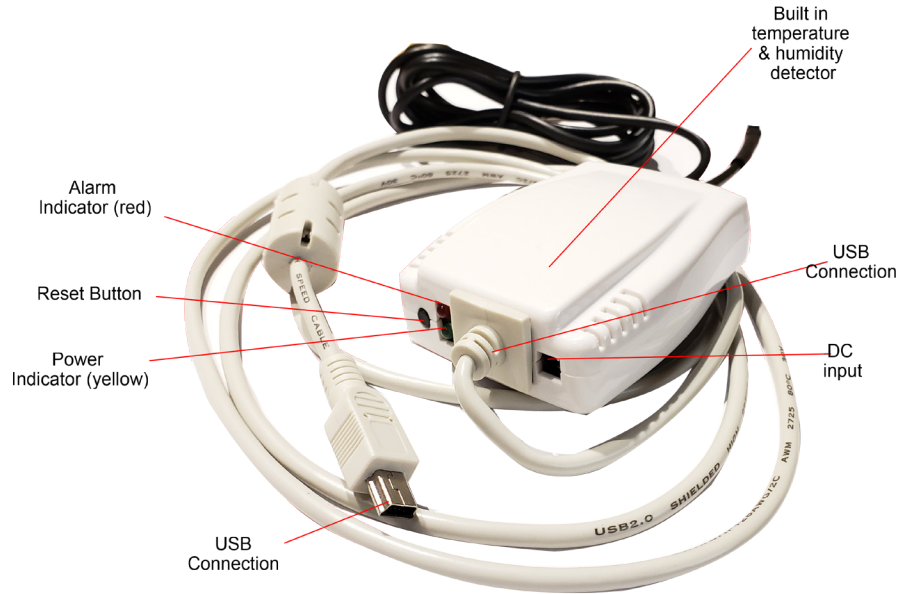

Description	
Red LED	Power
Yellow LED	Alarm Indicator
Reset button	To turn off alarm
Power supply	from SNMP-3PEX
RS232 port	To connect to SNMP-2PV2
RFID Switch	Used for pairing SNMP-EMPV2 with wireless devices

### How to Set RFID

1. Set RFID switch 1 and 2: "on"
2. Set RFID switch 3 to 8: "off"

Once set, the combinations will be used to pair other wireless device to SNMP-EMP.

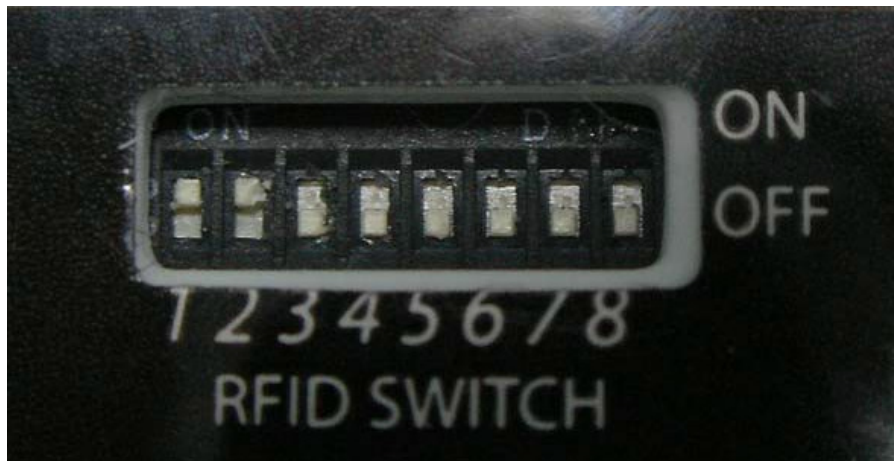

SNMP-EMPV2 RFID Switch

SNMP-EMP has 9 different slots to identifying wireless device. Each is allocated a default binary or DIP equivalent settings. Only the binary reference for smoke and gas sensors are fixed. The binary reference from 1 to 7 are interchangeable.

**Where:**

"1" or "+" = short pins **H** and **N**

"0" or "-" = short pins **L** and **N**

Default Sensor Type	Binary	Web Reference
Smoke	1010	Smoke (fixed)
Gas	0010	Gas (fixed)
	1110	1
	1101	2
	1100	3
Door / Window	1011	4
	1010	5
PIR	1001	6
	1000	7
Glass	0101	
Beam	0011	

### ***How to Set Wireless Smoke/Gas Sensor***

The smoke sensor is designed to detect smoke. It will produce a loud continuous buzz when is detected.

Gas sensor can detect presence of coal gas, natural gas and liquefied petroleum gas. When a leakage is detected, the gas sensor will buzz.

An external 9~12V power input is required for gas sensor.



**To setup:**

1. Open the cover (top part) of Wireless Smoke/Gas sensor to reveal two sets of DIP switches.
2. The bottom (longer) DIP switch show pins A0 to A7. This set of DIP is used to pair the wireless sensor with SNMP-EMPV2.

**Set these DIP as follows:**

1. DIP A0 to A1: set to "on"  
Connect pins from row H with middle pin using a jumper (see illustration below).
2. DIP A2 to A7: set to: "off"  
Connect pins from row L with middle pin using a jumper.

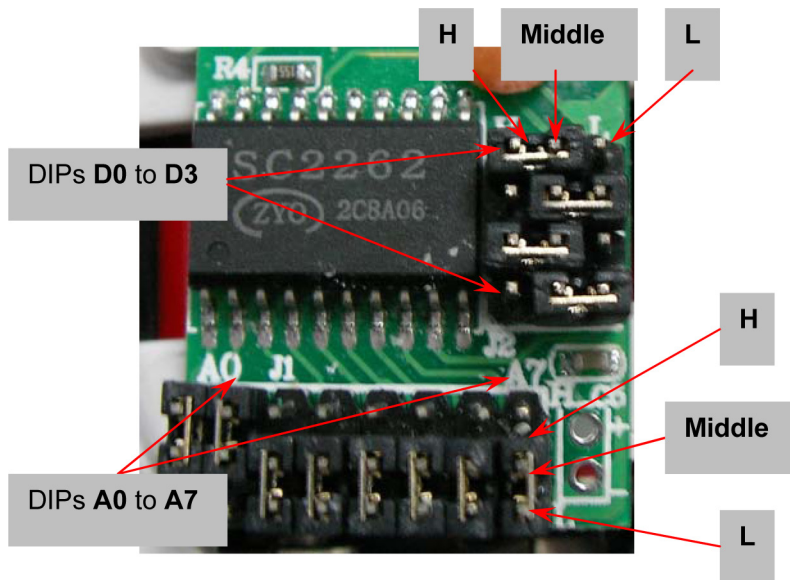

**Wireless Smoke Sensor DIP Switch**

3. The second set of DIP switch show 4 sets of pins. This set allow SNMP-EMP to identify the type of sensor.

Sensor Type	DIP settings
Gas	0010
Smoke	1010

**Wireless Smoke /Gas Sensor default Code**

***How to Set Wireless Door/Window Sensor***

Use the Wireless Door / Window sensor to secure the front door, balcony entrance or window. When there is an intrusion, the sensor will signal SNMP-EMP to sound an alarm.



**To setup:**

Open the Door / Window sensor casing (use a flat head screwdriver and pry it open from the bottom). Inside will be one long row of DIP switches.

Set these DIP as follows:

1. DIP A0 to A1: set to "on"  
Connect pins from row H and row N using a jumper (see illustration below).
2. DIP A2 to A7: set to: "off"  
Connect pins from row L and row N using a jumper.

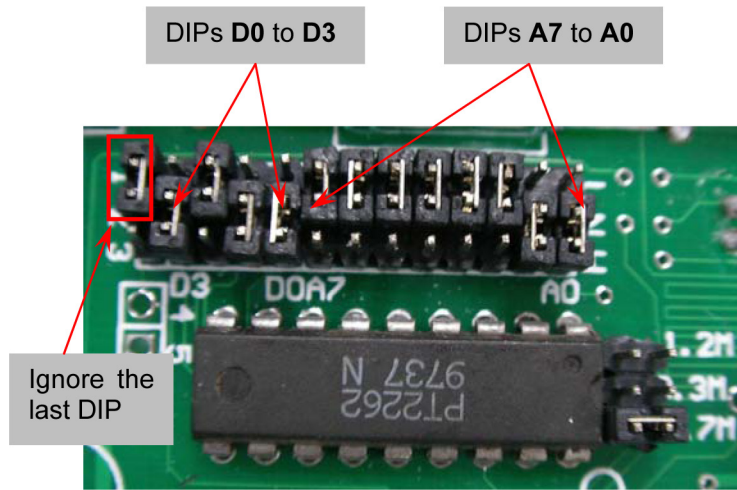

Wireless Door / Window sensor DIP Switch

Sensor Type	DIP settings
Door / Window	1011

Wireless Door / Window sensor (D0 to D3)

**How to Set Wireless Glass-break Sensor**

The wireless glass-break sensor is used to protect against unauthorized access by breaking glass window / door. Install the sensor on the wall or ceiling next to the glass window / door. If the glass is broken, SNMP-EMP will sound an alarm.

**Note:** An external 9~12V power input is required.





**To setup:**

1. Press down on the lever located top-back side of the unit to open the case.
2. Carefully flip over the smaller DIP switch PCB.
3. Set DIPs A0 to A7 the same as the wireless smoke / gas sensor in the section above.

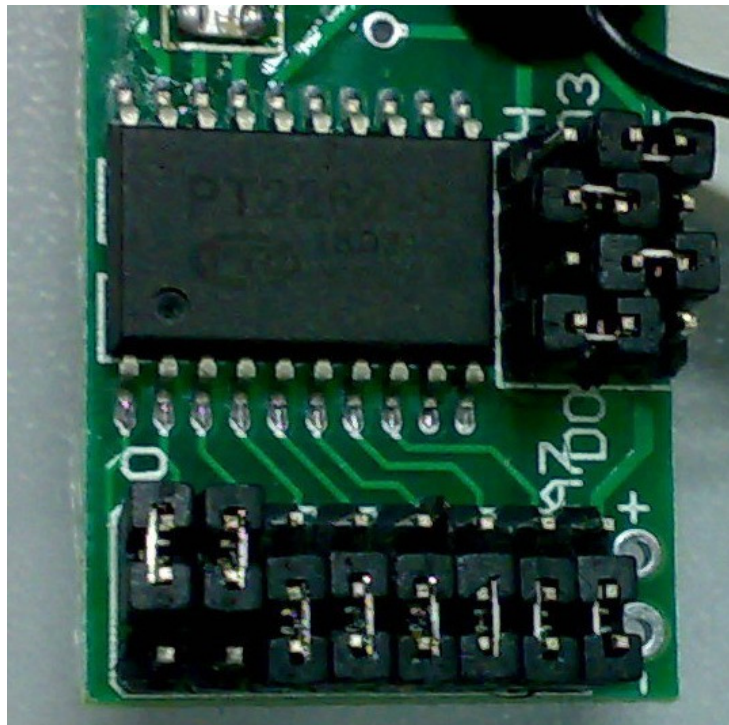

Wireless glass sensor DIP switch

Sensor Type	DIP settings
Glass	0101

Wireless glass sensor DIP setting

***How to Set InfraRed Beam Detector***

InfraRed Beam Detector can be installed on a fence, door, window, access way, corridor, balcony or where access detection is required. If the InfraRed Beam is interrupted, the detector will sound an alarm and send a signal to SNMP-EMP.

**Note:** An external 9~12V power input is required.



**To setup:**

1. Hold both caps (black) on the InfraRed Beam detector and pull in opposite direction to reveal the DIP switch.
2. Locate DIPs number 1 to 8 and set to “+ + - - - - -”
3. The next set of DIP switch on the right is labeled in reverse from 13 to 10. Set these from RIGHT to LEFT “- - + +”

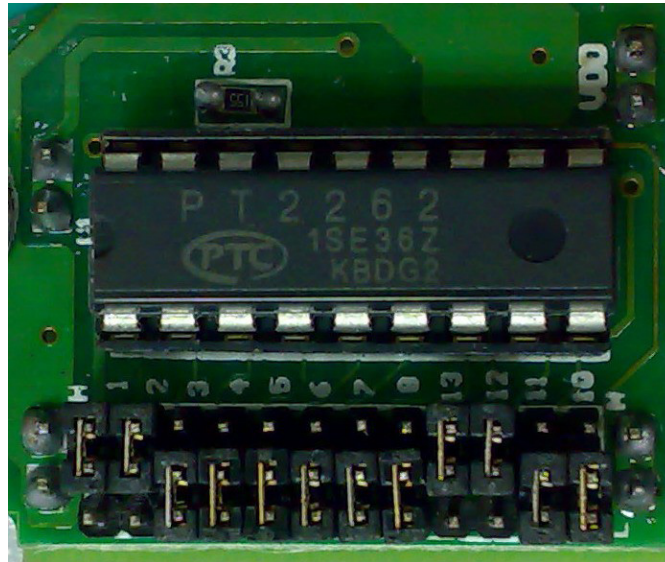

**InfraRed Beam detector DIP Switch**

Sensor Type	DIP settings
InfraRed Beam detector	0011

**InfraRed Beam detector default Code(Right DIP Switch)**

***How to Set PIR Sensor***

Passive Infrared (“PIR”) sensor is usually used for motion detection over an area. It is triggered by sudden changes in temperature over the detection range.

PIR sensor is normally installed in important rooms, on walls, ceiling or passageway. PIR will be triggered when there is an unauthorized access and a signal will be sent to SNMP-EMPV2.



**To setup the device:**

1. Open the cover by removing the screw located at the bottom of the unit.
2. Set the first 8 DIP switches (from LEFT to RIGHT) “+ + - - - - - - - -”
3. Set the next for DIPs 13 to 10 (from RIGHT to LEFT) “+ - - +”



**PIR DIP switch**

Sensor Type	DIP settings
PIR	1001

**Fig. 12 PIR code (from RIGHT to LEFT DIP Switch)**